

UPO1000CS Series Digital Phosphor Oscilloscope

User's Manual

REV 1

2022.11.11

UNI-T®

Forehead

Dear Users,

Hello! Thank you for choosing this brand new UNI-T instrument. In order to use this instrument safely and correctly, please read this manual thoroughly, especially the Safety Requirements part.

After reading this manual, it is recommended to keep the manual at an easily accessible place, preferably close to the device, for future reference.

Copyright Information

Uni-Trend Technology (China) Co., Ltd. All rights reserved.

Trademark Information

UNI-T is the registered trademark of Uni-Trend Technology (China) Co., Ltd.

Document Version

UPO1000CS-20211231-V1.00

Statement

- **UNI-T** products are protected by patent rights in China and foreign countries, including issued and pending patents.
- **UNI-T** reserves the rights to any product specification and pricing changes.
- **UNI-T** reserves all rights. Licensed software products are properties of Uni-Trend and its subsidiaries or suppliers, which are protected by national copyright laws and international treaty provisions. Information in this manual supersedes all previously published versions.

Warranty

UNI-T warrants that the product will be free from defects for a three-year period. If the product is re-sold, the warranty period will be from the date of the original purchase from an authorized UNI-T distributor. Probes, other accessories, and fuses are not included in this warranty.

If the product is proved to be defective within the warranty period, UNI-T reserves the rights to either repair the defective product without charging of parts and labor, or exchange the defected product to a working equivalent product. Replacement parts and products may be brand new, or perform at the same specifications as brand new products. All replacement parts, modules, and products become the property of UNI-T.

The "customer" refers to the individual or entity that is declared in the guarantee. In order to obtain the warranty service, "customer" must inform the defects within the applicable warranty period to UNI-T, and to perform appropriate arrangements for the warranty service. The customer shall be responsible for packing and shipping the defective products to the designated maintenance center of UNI-T, pay the shipping cost, and provide a copy of the purchase receipt of the original purchaser. If the product is shipped domestically to the location of the UNI-T service center, UNI-T shall pay the return shipping fee. If the product is sent to any other location, the customer shall be responsible for all shipping, duties, taxes, and any other expenses.

This warranty shall not apply to any defects or damages caused by accidental, machine parts' wear and tear, improper use, and improper or lack of maintenance. UNI-T under the provisions of this warranty has no obligation to provide the following services:

- a) Any repair damage caused by the installation, repair, or maintenance of the product by non UNI-T service representatives.
- b) Any repair damage caused by improper use or connection to an incompatible device.
- c) Any damage or malfunction caused by the use of a power source which does not conform to the requirements of this manual.
- d) Any maintenance on altered or integrated products (if such alteration or integration leads to an increase in time or difficulty of product maintenance).

This warranty is written by UNI-T for this product, and it is used to substitute any other express or implied warranties. UNI-T and its distributors do not offer any implied warranties for merchantability or applicability purposes.

For violation of this guarantee, regardless of whether UNI-T and its distributors are informed that any indirect, special, incidental, or consequential damage may occur, UNI-T and its distributors shall not be responsible for any of the damages.













1. Introduction





This manual includes safety requirements, installment and the operation of UPO1000CS oscilloscope.

2. Safety Requirement

This section contains information and warnings that must be followed to keep the instrument operating under safety conditions. In addition, user should also follow the common safety procedures.

Safety Precautions	
Warning	Please follow the following guidelines to avoid possible electric shock and risk to personal safety.
	Users must follow the following conventional safety precautions in operation, service and maintenance of this device. UNI-T will not be liable for any personal safety and property loss caused by the user's failure to follow the following safety precautions. This device is designed for professional users and responsible organizations for measurement purposes. Do not use this device in any way not specified by the manufacturer. This device is only for indoor use unless otherwise specified in the product manual.
Safety Statement	
Warning	"Warning" indicates the presence of a hazard. It reminds users to pay attention to a certain operation process, operation method or similar. Personal injury or death may occur if the rules in the "Warning" statement are not properly executed or observed. Do not proceed to the next step until you fully understand and meet the conditions stated in the "Warning" statement.
Caution	"Caution" indicates the presence of a hazard. It reminds users to pay attention to a certain operation process, operation method or similar. Product damage or loss of important data may occur if the rules in the "Caution" statement are not properly executed or observed. Do not proceed to the next step until you fully understand and meet the conditions stated in the "Caution" statement.
Note	"Note" indicates important information. It reminds users to pay attention to procedures, methods and conditions, etc. The contents of the "Note" should be highlighted if necessary.
Safety Sign	

	Danger	It indicates possible danger of electric shock, which may cause personal injury or death.
	Warning	It indicates that you should be careful to avoid personal injury or product damage.
	Caution	It indicates possible danger, which may cause damage to this device or other equipment if you fail to follow a certain procedure or condition. If the "Caution" sign is present, all conditions must be met before you proceed to operation.
	Note	It indicates potential problems, which may cause failure of this device if you fail to follow a certain procedure or condition. If the "Note" sign is present, all conditions must be met before this device will function properly.
	AC	Alternating current of device. Please check the region's voltage range.
	DC	Direct current device. Please check the region's voltage range.
	Grounding	Frame and chassis grounding terminal.
	Grounding	Protective grounding terminal.
	Grounding	Measuring grounding terminal.
	OFF	Main power off.
	ON	Main power on.
	Power Supply	Standby power supply: when the power switch is turned off, this device is not completely disconnected from the AC power supply.
CAT I		Secondary electrical circuit connected to wall sockets through transformers or similar equipment, such as electronic instruments and electronic equipment; electronic equipment with protective measures, and any high-voltage and low-voltage circuits, such as the copier in the office.
CAT II		CATII: Primary electrical circuit of the electrical equipment connected to the indoor socket via the power cord, such as mobile tools, home appliances, etc. Household appliances, portable tools (e.g. electric drill), household sockets, sockets more than 10 meters away from CAT III circuit or sockets more than 20 meters away from CAT IV circuit

CAT III		Primary circuit of large equipment directly connected to the distribution board and circuit between the distribution board and the socket (three-phase distributor circuit includes a single commercial lighting circuit). Fixed equipment, such as multi-phase motor and multi-phase fuse box; lighting equipment and lines inside large buildings; machine tools and power distribution boards at industrial sites (workshops).
CAT IV		Three-phase public power unit and outdoor power supply line equipment. Equipment designed to “initial connection”, such as power distribution system of power station, power instrument, front-end overload protection, and any outdoor transmission line.
	Certification	CE indicates a registered trademark of EU.
	Certification	UKCA indicates a registered trademark of United Kingdom.
	Certification	Conforms to UL STD 61010-1, 61010-2-030, Certified to CSA STD C22.2 No. 61010-1, 61010-2-030.
	Waste	Do not place equipment and its accessories in the trash. Items must be properly disposed of in accordance with local regulations.
	EFUP	This environment-friendly use period (EFUP) mark indicates that dangerous or toxic substances will not leak or cause damage within this indicated time period. The environment-friendly use period of this product is 40 years, during which it can be used safely. Upon expiration of this period, it should enter the recycling system.
Safety Requirements		
Warning		
Preparation before use		Please connect this device to AC power supply with the power cable provided; The AC input voltage of the line reaches the rated value of this device. See the product manual for specific rated value. The line voltage switch of this device matches the line voltage; The line voltage of the line fuse of this device is correct. Do not used to measure MAINS CIRCUIT.
Check all terminal rated values		Please check all rated values and marking instructions on the product to avoid fire and impact of excessive current. Please consult the product manual for detailed rated values before connection.

Use the power cord properly	You can only use the special power cord for the instrument approved by the local and state standards. Please check whether the insulation layer of the cord is damaged or the cord is exposed, and test whether the cord is conductive. If the cord is damaged, please replace it before using the instrument.
Instrument Grounding	To avoid electric shock, the grounding conductor must be connected to the ground. This product is grounded through the grounding conductor of the power supply. Please be sure to ground this product before it is powered on.
AC power supply	Please use the AC power supply specified for this device. Please use the power cord approved by your country and confirm that the insulation layer is not damaged.
Electrostatic prevention	This device may be damaged by static electricity, so it should be tested in the anti-static area if possible. Before the power cable is connected to this device, the internal and external conductors should be grounded briefly to release static electricity. The protection grade of this device is 4KV for contact discharge and 8KV for air discharge.
Measurement accessories	Measurement accessories are of lower class, which are definitely not applicable to main power supply measurement, CAT II, CAT III or CAT IV circuit measurement. Probe assemblies and accessories within the scope of IEC 61010-031, and current sensors within the scope of IEC 61010-2-032 shall meet the requirements thereof.
Use the input / output port of this device properly	Please use the input / output ports provided by this device in a properly manner. Do not load any input signal at the output port of this device. Do not load any signal that does not reach the rated value at the input port of this device. The probe or other connection accessories should be effectively grounded to avoid product damage or abnormal function. Please refer to the product manual for the rated value of the input / output port of this device.
Power fuse	Please use power fuse of specified specification. If the fuse needs to be replaced, it must be replaced with another one that meets the specified specifications (Class T, rated current 5A, rated voltage 250V) by the maintenance personnel authorized by UNI-T.

Disassembly and cleaning	<p>There are no components available to operators inside. Do not remove the protective cover.</p> <p>Maintenance must be carried out by qualified personnel.</p>
Service environment	<p>This device should be used indoors in a clean and dry environment with ambient temperature from 0 °C to 40 °C.</p> <p>Do not use this device in explosive, dusty or humid air.</p>
Do not operate in humid environment	Do not use this device in a humid environment to avoid the risk of internal short circuit or electric shock.
Do not operate in flammable and explosive environment	Do not use this device in a flammable and explosive environment to avoid product damage or personal injury.
Caution	
Abnormity	If this device may be faulty, please contact the authorized maintenance personnel of UNI-T for testing. Any maintenance, adjustment or parts replacement must be done by the relevant personnel of UNI-T.
Cooling	<p>Do not block the ventilation holes at the side and back of this device;</p> <p>Do not allow any external objects to enter this device via ventilation holes;</p> <p>Please ensure adequate ventilation, and leave a gap of at least 15 cm on both sides, front and back of this device.</p>
Safe transportation	Please transport this device safely to prevent it from sliding, which may damage the buttons, knobs or interfaces on the instrument panel.
Proper ventilation	Poor ventilation will cause the device temperature to rise, thus causing damage to this device. Please keep proper ventilation during use, and regularly check the vents and fans.
Keep clean and dry	Please take actions to avoid dust or moisture in the air affecting the performance of this device. Please keep the product surface clean and dry.
Note	
Calibration	The recommended calibration period is one year. Calibration should only be carried out by qualified personnel.

Environmental Requirements

This instrument is suitable for the following environment:

- Indoor use.
- Pollution degree 2
- In operating: altitude lower to 3000 meter; in non-operating: altitude lower to 15000 meter.
- Operating temperature 0 °C to + 40 °C; Storage temperature -20 °C to +70 °C (unless otherwise specified).
- In operating, humidity temperature below to +35 °C, ≤90% relative humidity;
In non-operating, humidity temperature +35 °C to +40 °C, ≤60% relative humidity.

There are ventilation opening on the rear panel and side panel of the instrument. So please keep the air flowing through the vents of the instrument housing. To prevent excessive dust from blocking the vents, please clean the instrument housing regularly. The housing is not waterproof, please disconnect the power supply first and then wipe the housing with a dry cloth or a slightly moistened soft cloth.

Connecting Power Supply

The specification of AC power supply that can input

Voltage Range	Frequency
100-240VAC (Fluctuations±10%)	50/60Hz

Please use the attached power lead to connect to the power port.

Connecting to service cable

This instrument is a Class I safety product. The supplied power lead has good performance in terms of case ground. This spectrum analyzer is equipped with a three-prong power cable that meets international safety standards. It provides good case grounding performance for the specification of your country or region.

Please install AC power cable as follows:

- ensure the power cable is in a good condition.
- leave enough space for connecting the power cord.
- Plug the attached three-prong power cable into a well-grounded power socket.

Electrostatic Protection

Electrostatic discharge may cause damage to component. Components can be damaged invisibly by electrostatic discharge during transportation, storage and use.

The following measure can reduce the damage of electrostatic discharge,

- Testing in antistatic area as far as possible;
- Before connecting the power cable to the instrument, inner and outer conductors of the instrument should be briefly grounded to discharge static electricity;
- Ensure all the instruments are properly grounded to prevent the accumulation of static.

3. Introduction of UPO1000CS Series Digital Phosphor Oscilloscope

UPO1000CS Series contains the following 2 models

Model	Analog Channel	Bandwidth
UPO1202CS	2	200MHz
UPO1102CS	2	100MHz

UPO1000CS Series digital phosphor oscilloscope is based on unique Ultra Phosphor technology. A multi-functional, high performance oscilloscope that is easy to use, with excellent technical specifications, a perfect combination of many functionalities that can help users to quickly complete testing. UPO1000CS series is aimed at satisfying the most extensive oscilloscope markets, including communications, semiconductors, computers, meter and instruments, aerospace defense, instrumentation, industrial electronics, consumer electronics, automotive electronics, field maintenance, R&D, education, etc.

Main Features:

- Analog channel bandwidth: 200MHz, 100MHz
- Analog channel: 2
- Sampling rate: 1 GS/s (not interleaving, each channel is independent sampling)
- Vertical scale: 1 mV/div-20 V/div
- Ground noise: < 100 μ Vrms
- Storage depth: 56 Mpts (per channel)
- Waveform capture rate of up to 500,000 wfms/s
- Hardware real-time continuous recording up to 100,000 frames
- Automatic measurement of 35 waveform parameters
- Multi-Scopes supports two channels independent trigger fluorescent display
- Two channels with independent hardware 7 digits frequency meter
- DVM supports two channels independent AC/DC TRMS (true virtual value) measurement
- Waveform operation: FFT, add, subtract, multiply, divide, digital filter, logical operation and advanced operation
- 1M points enhance FFT function, supporting frequency setting, waterfall curve, detection setting and mark measurement

- Abundant trigger functions: edge, pulse width, video, slope, runt pulse, over-amplitude pulse, delay, timeout, duration, setup hold, Nth edge and pattern trigger
- Supporting RS232, I²C, SPI, CAN and LIN trigger
- Creative hardware decoding function: RS232, I²C, SPI, CAN and LIN, hardware decoding and full and deep storage decoding function
- Ultra Phosphor display, 256 level gray scale display
- 7 inch WVGA (800×480) TFT LCD
- Multiple interface: USB-Host, USB-Device, LAN, EXT Trig, AUX Out (Trig Out, Pass/Fail)
- Supporting SCPI programmable standard command
- Support WEB access and control

4. Getting Started Guide

4.1 General Inspection

4.2 Before Use

4.3 Front Panel

4.4 Rear Panel

4.5 Operation Panels

4.6 User Interface

4.7 Introduction of Special Symbol

This chapter introduces on using the oscilloscope for the first time, the front and rear panels, the user interface, as well as the built-in help system.

4.1 General Inspection

It is recommended to inspect the instrument follow the steps below before using the UPO1000CS series for the first time.

(1) Check for Damages caused by Transport

If the packaging carton or the foam plastic cushions are severely damaged, please contact the UNI-T distributor of this product immediately.

(2) Check Attachment

Please check appendix for the list of accessories. If any of the accessories are missing or damaged, please contact UNI-T or local distributors of this product.

(3) Machine Inspection

If the instrument appears to be damaged, not working properly, or has failed the functionality test, please contact UNI-T or local distributors of this product.

If the equipment is damaged due to shipping, please keep the packaging and notify both the transportation department and UNI-T distributors, UNI-T will arrange maintenance or replacement.

4.2 Before Use

To perform a quick verification of the instrument's normal operations, please follow the steps below:

(1) Connect to the Power Supply

The power supply voltage range is from 100 VAC to 240 VAC, the frequency range is 50/60Hz. Connect the oscilloscope to the power supply line that came with the oscilloscope or any power supply line that meets the local country standards. Turn on the power button, which on the back of the oscilloscope. The soft power button  in the front of the oscilloscope should be on red. Press this button to turn on the oscilloscope.

(2) Boot Check

Press the soft power button  and the light should change to green. The oscilloscope will show a boot animation, and then enter the normal interface.

(3) Connect Probe

Use probe in the attachment and connect it BNC port to the channel 1 BNC port of the oscilloscope. Connect the probe's main alligator clip to the "Compensating signal port" and the ground clip is connected to the "Ground terminal" shown below. The output of the compensating signal should be amplitude 3Vpp, default frequency is 1 kHz.

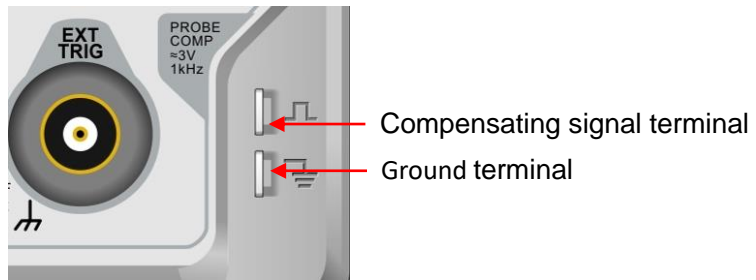

Figure 4-1 Compensating signal and Ground terminal

(4) Function Check

Press the AUTO key, a 3 Vpp 1 kHz square wave should appear. Repeat step 3 for all channels. If the output is not a square wave with the above descriptions, please perform the probe compensation step in the next section.

(5) Probe Compensation

When the probe is connected to any input channel for the first time, this step might be adjusted in order to match the probe and the input channel. Probes that are not compensated may lead to measurement errors or mistake. Please follow the following steps:

① Set the attenuation coefficient in the probe menu and the switch on the probe to 10x, and connect the probe to CH1. Make sure the probe's connector is properly connected with the oscilloscope. Connect the probe's main clip and ground clip to the oscilloscope's compensating signal and ground terminal respectively. Open CH1 and press the AUTO button.

② View displayed waveforms, as shown in Figure 4-2.

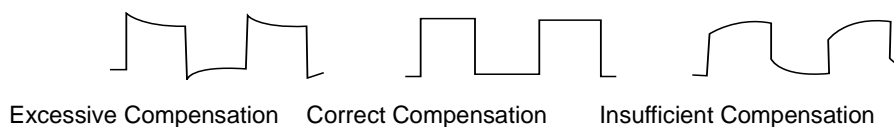

Figure 4-2 Compensating Calibration of Probe

③ If the displayed waveform is look like the above “Insufficient Compensation” or “Excessive Compensation”, use a non-metallic screwdriver to adjust the probe's variable capacitance until the display matches the "Correct compensation" waveform.

Warning: To avoid electric shock when using the probe to measure high voltage, please ensure that the probe insulation is in good condition and avoid physical contact with any metallic part of the probe.

4.3 Front Panel

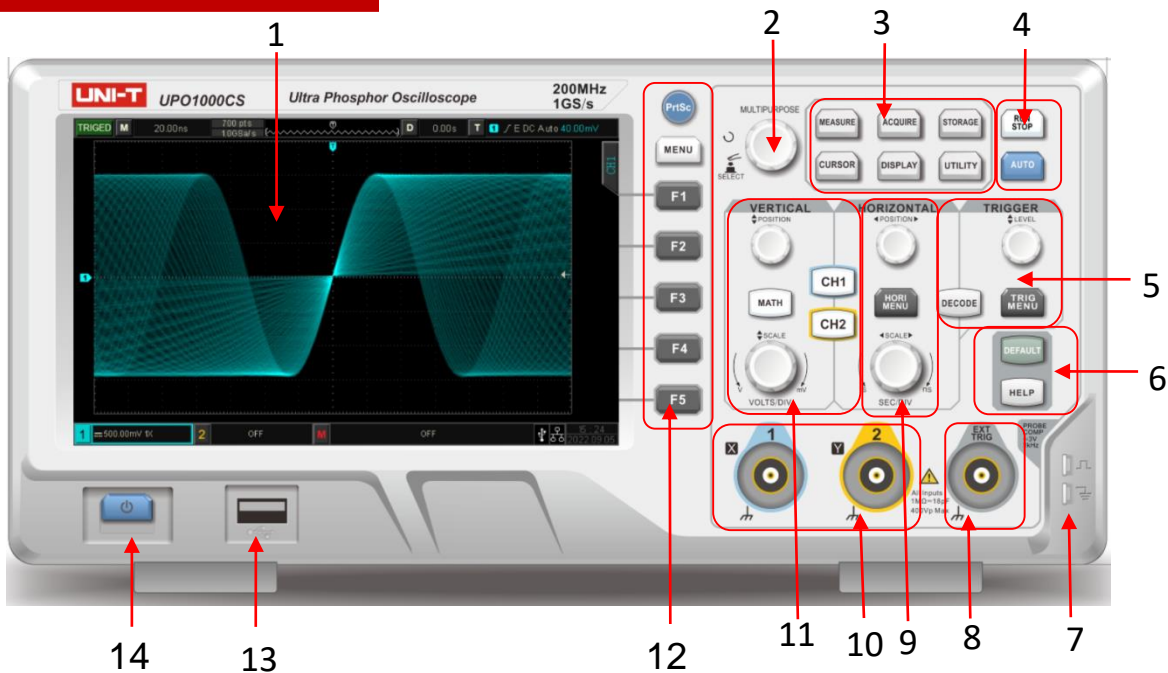

Figure 4-3 Front Panel

1. Screen display area
2. Multipurpose knob
3. Function menu
4. Run/Stop, Automatic setting key
5. TRIGGER control
6. Default, Help menu
7. Compensation signal and Ground terminal
8. EXT (External trigger input) port
9. Horizontal control area
10. Analog channel input port
11. Vertical control area
12. Control menu, copy key
13. USB HOST interface
14. Power on/off

4.4 Rear Panel

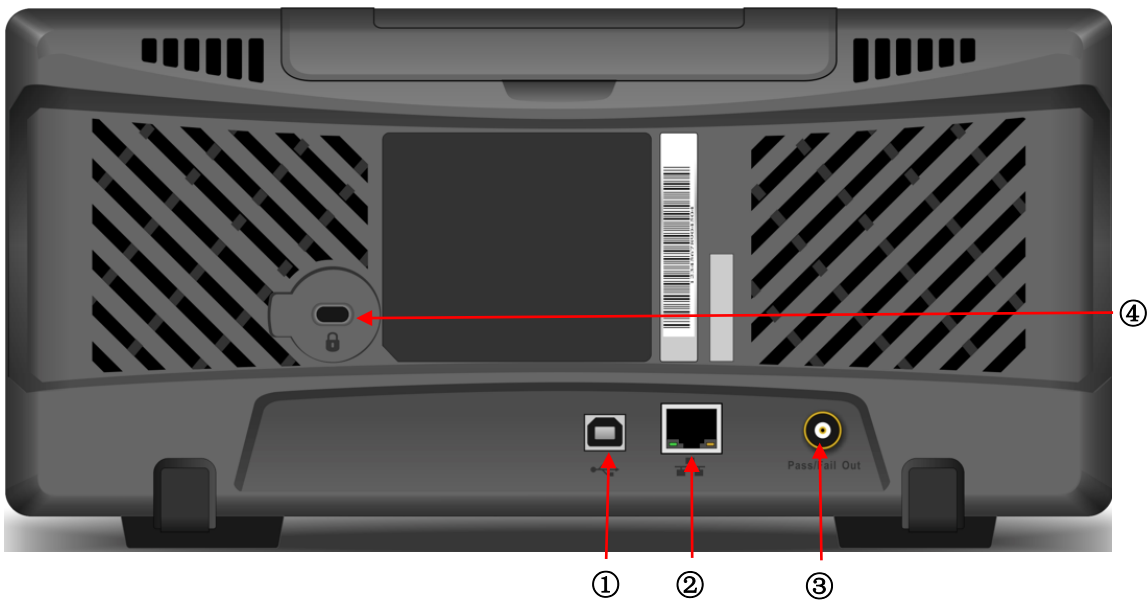
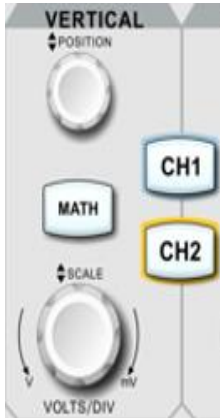

Figure 4-4 Rear Panel

- ①. USB Device: USB Device interface, it can be used to communicate with the PC
- ②. LAN : The oscilloscope can be connected to the LAN network for remote control
- ③. Pass/Fail output port: Pass/Fail test output, Trig_out signal
- ④. Safety Lock: Optional safety lock (sold separately) can be used for the oscilloscope stay at fixed position

4.5 Operation Panel

(1) Vertical Control



- ① **CH1** , **CH2** : Analog channel setting keys, CH1, CH2 identified by different colors and it also corresponding to the colors of waveforms on the screen and channel input connectors. Press any key to turn on the related channel menu (activate or disable channel).
- ② **MATH** : Press this key to open the mathematical operation menu for add, subtract, multiply, divide, FFT, logical operations, digital filtering and advanced operations.
- ③ Vertical **POSITION** : Adjust the vertical position to move the current channel waveform, the vertical offset value **240.00mV** will display at the baseline cursor. Press this knob to return the channel display back to the vertical midpoint.
- ④ Vertical **SCALE** : Vertical position knob is used for adjusting the vertical scale, turn clockwise to decrease the scale, turn counterclockwise to increase the scale. With this process, waveform will display increasing or decreasing and position information **1 = 100V X** will also be presented at the same time. The vertical scale stepped as 1-2-5 order. Press the knob allows the vertical adjustment to switch between coarse and fine adjustment mode.

(2) Horizontal Control



- ① **HORI MENU** : Horizontal menu is for display window extension, Multi-Scopes, timebase (XY/YT) and trigger holdoff.
- ② Horizontal **POSITION** : Adjusting the horizontal position knob, the trigger point moves around the left or right of the center of the screen, and the waveform of all the channel moves to left or right. Horizontal position parameter **D 0.00s** will display on the top of the screen in real-time. Press this knob to return the channel display back to the midpoint position.
- ③ Horizontal **SCALE** : Used to adjust the time base of all the channel. Screen will display the changes of the waveform, compressed or extension on horizontal. Time base **M 100µs** will display on the top of the screen in real-time. The time base scale stepped as 1-2-5 order. Press the knob allows the horizontal adjustment to switch between window display and extension window.

(3) Trigger Control



- ① **LEVEL** : Adjusting the trigger level. Turn clockwise to increase the level and turn counterclockwise to decrease the level. During the adjustment, the trigger level at the top right corner of the screen **T E/DC 0.000μV** will change accordingly. Press this knob to quickly reset the trigger level back to 50% trigger signal position.
- ② **TRIG MENU** : Press to display the trigger menu. For more details, please refer to “Trigger Setting”.
- ③ **DECODE**: Set bus decoding, the specific refer to “DECODE”.

(4) Auto Setting



Press this key to enable the auto setting function. The oscilloscope will automatically adjust the vertical scale, scan timebase and trigger mode according to the input signal to realize optimum waveform display.

Note: Waveform auto setting function requires that the frequency of sine is no lower than 20 Hz; the amplitude must be at least 20 mVpp~120 Vpp. Otherwise, the waveform auto setting function may be invalid.

(5) Run/Stop



Press this key set the operating state to "RUN" or "STOP".

In the "RUN" state, the key is illuminated in green.

In the "STOP" state, the key is illuminated in red.

(6) PrintScreen



Press this knob to save waveform as bmp format image into USB device.

(7) Multipurpose Knob



Multipurpose: Turn the knob to select sub-menu, then press the knob to confirm the selection.

(8) Function Key



- ① **MEASURE**: Press this key to enable the measurement setting menu. It can set the measurement source, parameter measurement, user-defined parameter, measurement statistic, measure indicator and digital voltmeter. Turn on user-defined, it has 36 types of parameter measurement. Press Multipurpose knob to quick select parameter to measuring and the result will show on the bottom of the screen.
- ② **ACQUIRE** : Press this key to enter sampling setting menu, it can set sampling mode, deep storage and quick sampling.
- ③ **CURSOR** : Press this key to enter cursor measurement menu, it can set type of cursor measurement, information source and mode.
- ④ **DISPLAY** : Press this key to enter the display setting menu to set the display type, format, grid brightness, waveform brightness, backlight brightness, persistence time, color temperature, anti-color temperature, menu display and transparency.
- ⑤ **STORAGE** : Press this key to enter storage interface. Storage type includes setting, waveform, reference waveform and picture. It can also call back waveform and setting from storage. It can save in internal or external USB device.
- ⑥ **UTILITY** : Press this key to enter the auxiliary function setting menu. It can set auto-calibration, system information, language setting, waveform recording, pass/fail test, square wave output, frequency meter, output selection, time setting, IP setting, boot loading and delete data, etc.

4.6 User Interface

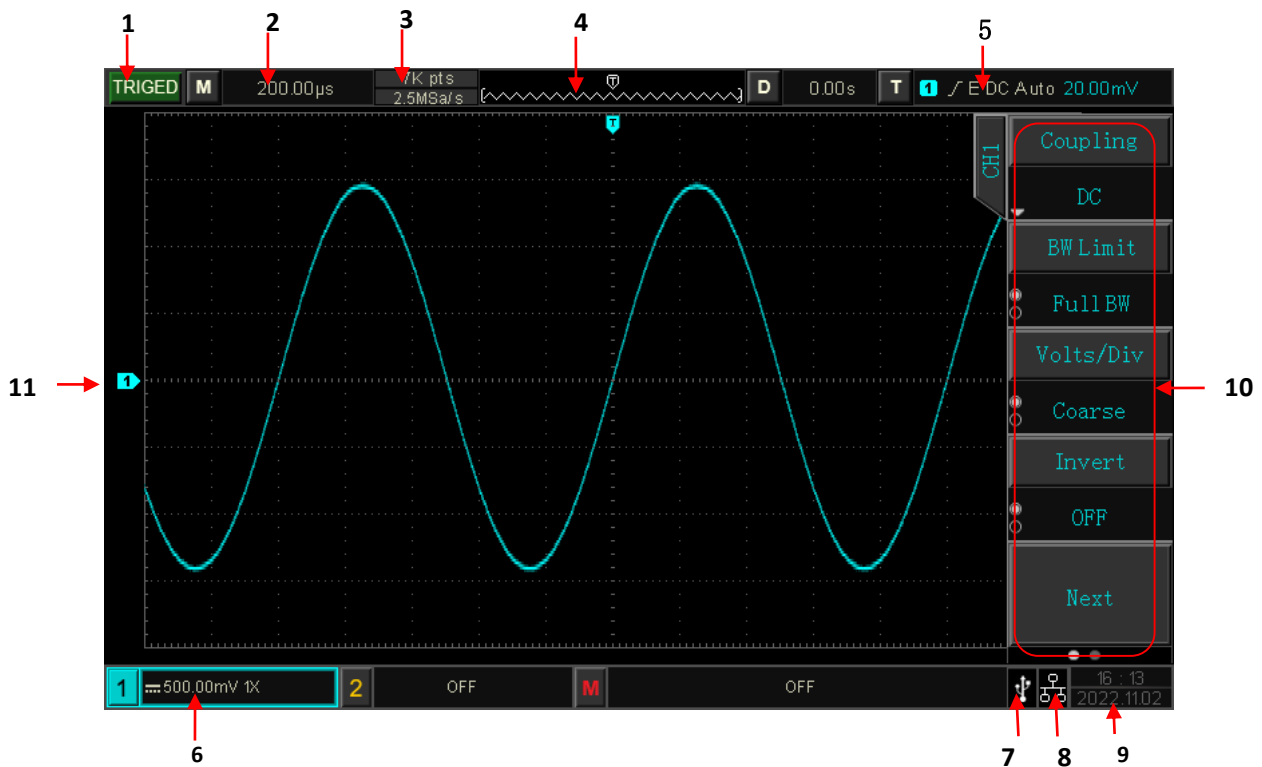





Figure 4-5 User Interface

User interface as shown in Figure 4-5 and the detailed description see the following.





- ① Trigger status identification: TRIGED (has been triggered), AUTO, READY, STOP, and ROLL.
- ② Timebase scale: Indicates the amount of time represented by one grid, which can be adjusted by the horizontal scale knob.
- ③ Sampling rate/Storage depth: Indicates sampling rate and storage depth of the current scale.
- ④ Horizontal displacement: Display the horizontal displacement value of waveform, which can adjusted by turning POSITION knob on the horizontal control. Press the knob returns the displacement back to 0.
- ⑤ Trigger status: Displays trigger source, type, slope, coupling, mode, level, etc.
 - a. Trigger source: There are CH1~CH2, mains electricity and EXT states. CH1~CH2 will display different trigger state colors based on channel colors. For example, **1** presents trigger source is CH1.
 - b. Trigger type: The types are edge, pulse width, video, slope, and advanced trigger. For example, **E** presents edge trigger.
 - c. Trigger slope: The types are rising, falling, and random. For example, **↗** presents rising edge trigger.
 - d. Trigger coupling: The types are DC, AC, HF rejection, LF rejection and noise. For example, **DC** indicates DC coupling.

- e. Trigger mode: Auto, normal and single.
 - f. Trigger level: Display the current trigger level, it corresponding to the right side of screen . Adjusting trigger control LEVEL knob in front of panel to change the parameter.
- ⑥ CH1 vertical scale identification: Display CH1 activation state, channel coupling, bandwidth limit, vertical scale and probe attenuation coefficient.
- a. Channel activation state: 
 - b. Bandwidth limitation: When the bandwidth limit function is turned on, an icon  will appear in the display
 - c. Vertical scale: Display the vertical scale of CH1. When CH1 is activated, the vertical scale can be adjusted with the vertical scale knob in front of panel.
 - d. Probe attenuation coefficient: Display CH1 probe attenuation coefficient 0.001x, 0.01x, 0.1x, 1x, 10x, 100x, 1000x and user-defined.
- ⑦ USB host identification: USB icon will be shown when USB device is connected.
- ⑧ LAN identification: LAN icon will be shown when network wire is connected.
- ⑨ The current date and time.
- ⑩ Soft key menu: Display the operation menu, press the corresponding knob to select menu. Press **F1** ~ **F5** to change the sub-menu.
- ⑪ Analog channel identification and Waveform: Display channel identification and waveform of CH1~CH2, the color of channel identification will be the same with waveform.

4.7 Introduction of Special Symbol



Take the left menu as example

-  This symbol presents there has the next menu
-  This symbol presents there has pull-down menu
-  This symbol presents there are two option
-  This symbol presents it can be adjusted by multipurpose knob
-  Circle number presents the page of menu, single page has no small circle, and two or more pages will have small circle display. Press F5 to turn pages.

5. Vertical Channel Settings

- 5.1 Turn on/off/Activate/ Analog Channel
- 5.2 Channel Coupling
- 5.3 Bandwidth Limitation
- 5.4 Volts/div
- 5.5 Reverse Phase
- 5.6 Probe
- 5.7 Unit

UPO1000CS provides two analog inputs channel, that is CH1~CH2. In this chapter, take the channel 1 as example to introduce vertical channel settings.

5.1 Turn on/off/Activate/ Analog Channel

CH1~CH2 contains three states: turn on, shut down and activate

- ① Turn on: Press to turn off any of [1], [2] key can turn on the corresponding channel.
- ② Shut down: In this state, it will not show waveform. Press the corresponding channel key to turn off which has been activated.
- ③ Activation: When multiple channel are enabled, only one channel can be activated (should be in open state). In the active state, vertical scale, vertical displacement and channel setting can be adjusted. Any of the channels that have been opened but not activated could be activated by the corresponding channel keys.



Activation state



Open but not activated



Shut down

5.2 Channel Coupling

Channel coupling has three mode direct current, alternating current and ground coupling.

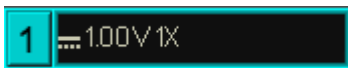

Direct Current



AC Current

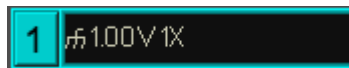

Ground

5.3 Bandwidth Limitation

The bandwidth limit can set to 20 MHz and full bandwidth, soft key menu set to 20 MHz. The bandwidth of the oscilloscope is limited to about 20 MHz and the high frequency signal above 20MHz in the attenuation signal. It is often used to observe high frequency noise when low frequency signals is reducing. When the bandwidth limit function is turned on, the B icon will appear in the vertical state, as shown in Figure below.



B Icon

5.4 Volts/div

Press vertical scale knob can switch to volts/div quickly, it divided into coarse and fine adjustments. The volts/div is from 1mV/div ~ 20V/div, with 1 -2- 5 order. In the coarse adjustment, it adjusts the vertical unit by normal order; in fine adjustment, it adjusts the current vertical position by stepped 1%.

5.5 Reverse Phase

When reverse phase is turned on, the voltage value of waveform will be reversed and the reverse icon  will display on the screen, as shown in Figure 5-2.

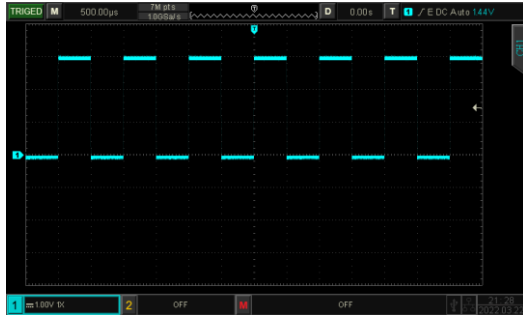

Figure 5-1 Reverse Phase Closed

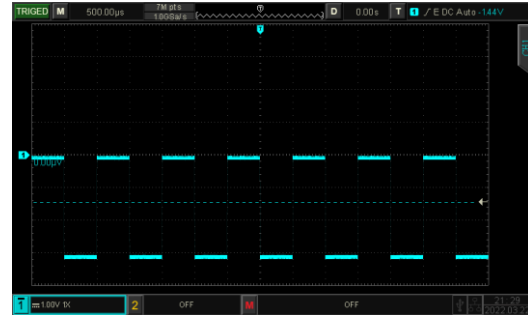

Figure 5-2 Open Reverse Phase

5.6 Probe

In order to match up the attenuation coefficient setting of the probe, the coefficient needs to be set up in the channel soft key menu. If the probe attenuation coefficient is 10:1, then the probe coefficient should set to 10X to ensure the correct voltage reading.

The probe can be set to 0.001X, 0.01X, 0.1x, 1x, 10x, 100x, 1000x and user-defined.

5.7 Unit

Set the amplitude unit for the current channel. Unit setting should set in channel, it can set to “V”, “A”, “W”, “U” and the default unit is V. After the setting, the unit in the channel status label and measurement unit will be change accordingly.

6. Horizontal System Settings

6.1 Horizontal Scale

6.2 ROLL Mode

6.3 Window Extension

6.4 XY

6.5 Multi-Scopes

6.6 Trigger Holdoff

6.1 Horizontal Scale

Horizontal scale which is horizontal time base, the time value represented by each scale in the horizontal direction of the display screen, usually expressed as s/div. Rotate the SCALE knob in the HORIZONTAL control area and set the horizontal scale according to 1-2-5 order, that is 1 ns/div, 2 ns/div, 5ns/div, 10 ns/div, 20 ns/div... 500 s/div, 1 ks/div. Turn clockwise to decrease the scale, turn counterclockwise to increase the scale. When adjusting the horizontal time base, the scale information will appear in the upper left corner of the screen (as shown in Figure 6-1), it changes in real time.

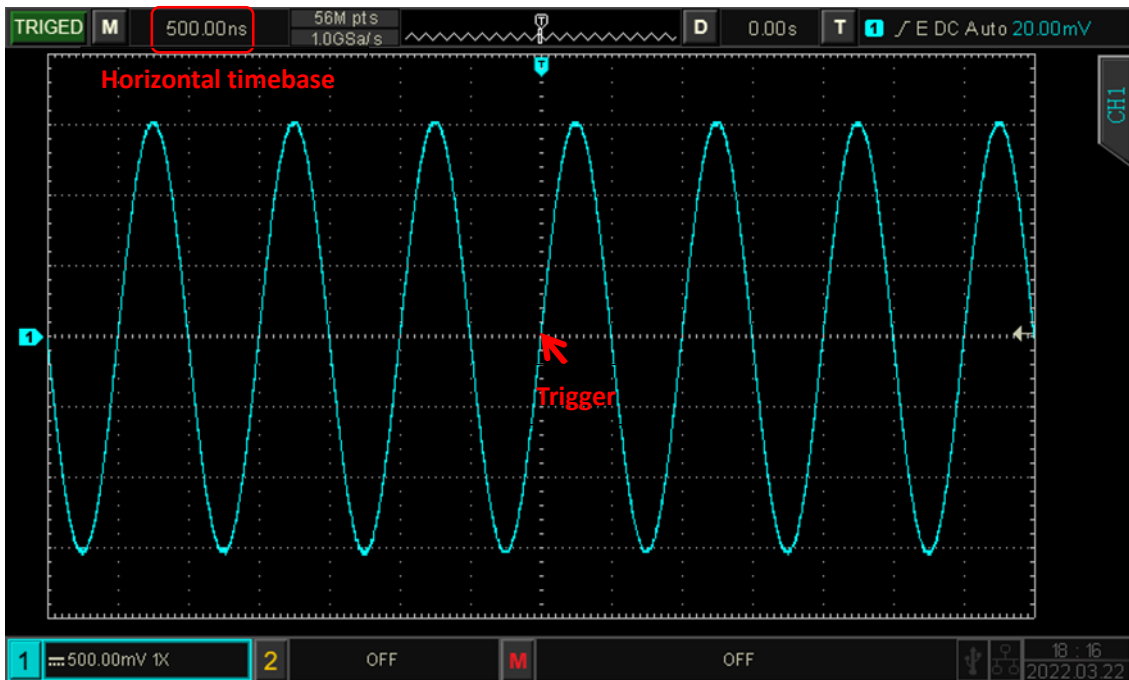

Figure 6-1

When the time base is changing, waveform will be change with trigger point to extension or compressed accordingly.

6.2 ROLL Mode

When trigger mode is in auto state, rotate SCALE knob in the HORIZONTAL control area, the oscilloscope will enter ROLL mode when horizontal scale slow to 20 ms/div.

The oscilloscope will continuously draw a voltage-time trend of the waveform on the screen. In this mode, the waveform is scrolled from right to left to refresh the display, and the latest waveform is drawn at the far right end of the screen. The diagram as shown in Figure 6-2.

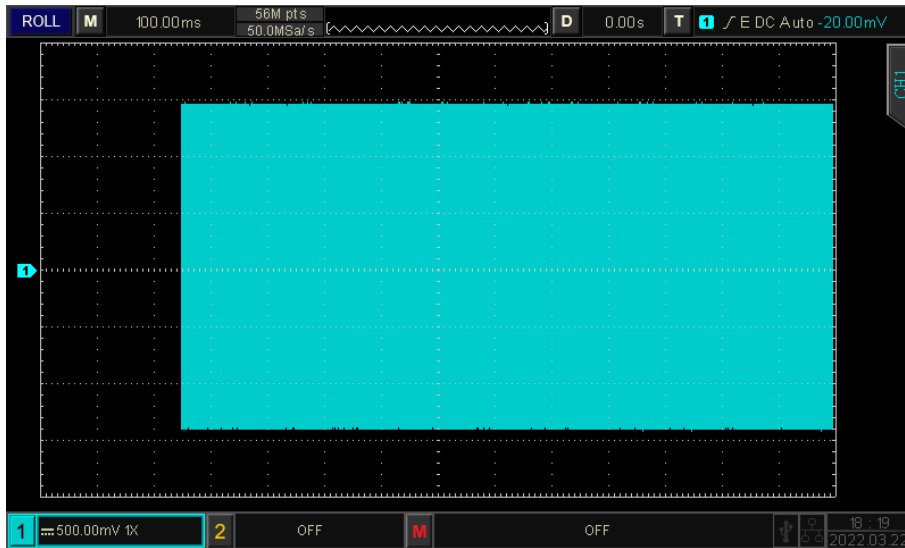

Figure 6-2

Apply to slow sweep mode to observe low-frequency signal, it's recommend that set the channel coupling mode to direct current.

Note: In ROLL mode, horizontal displacement, window extension, pass/fail test, parameter measurement, recording waveform and waveform brightness cannot be used.

6.3 Window Extension

Window extension is used for magnifying a waveform to view the image detail. In horizontal menu, it can open window extension or open it by press SCALE knob in the HORIZONTAL control area.

In window extension mode, screen will be divided into two display area as shown in Figure 6-3.

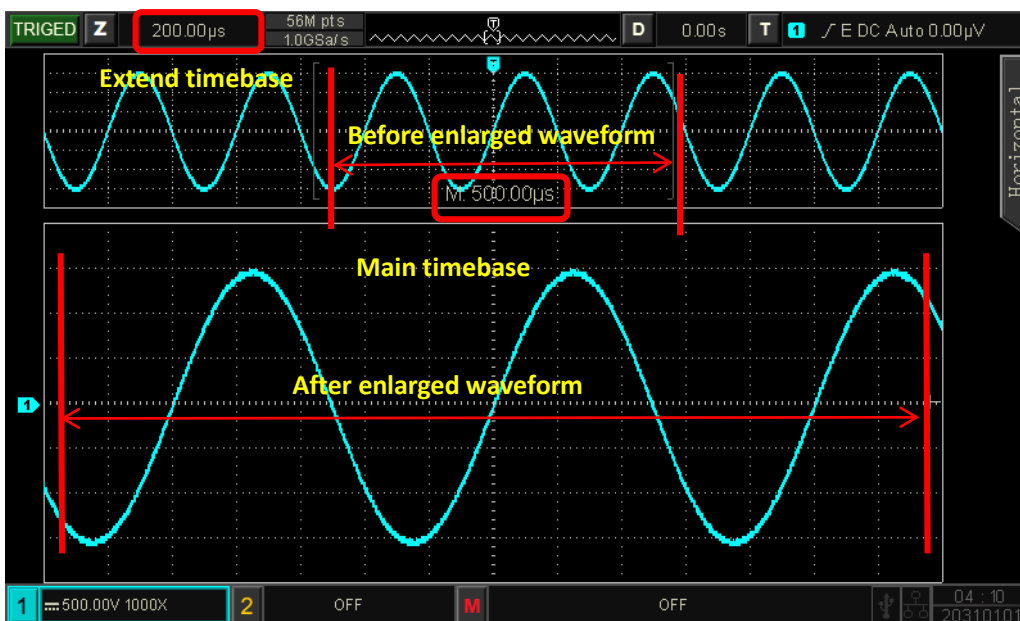

Figure 6-3

The waveform before amplification is shown in the square brackets on the upper part of the screen. It can move by horizontal position or adjusting time base to increasing or decreasing this area.

Enlarged Waveform

The enlarged waveform is displayed on the bottom part of the screen, window extension improves resolution relative to the main time base.

Note: Window extension requires that time base position should at 20 ms/div~2 ns/div. Only in this range, window extension can be functioned.

6.4 XY

The waveform displayed in XY mode is also called Lissajous curve.

In XY mode, input CH1 signal on the horizontal axis(X axis), input CH2 signal on the vertical axis (Y axis). In XY mode, when CH1 is activated, use POSITION knob in the vertical control area to move XY figure on the horizontal direction. When CH2 is activated, use POSITION knob in the vertical control area to move XY figure on the vertical direction.

Rotate the SCALE knob in the vertical control area to adjust amplitude scale of each channel, rotate the SCALE knob in the horizontal control area to adjust the time base, which can get a better display effect of Lissajous curve. Waveform in XY mode as shown in Figure 6-4.

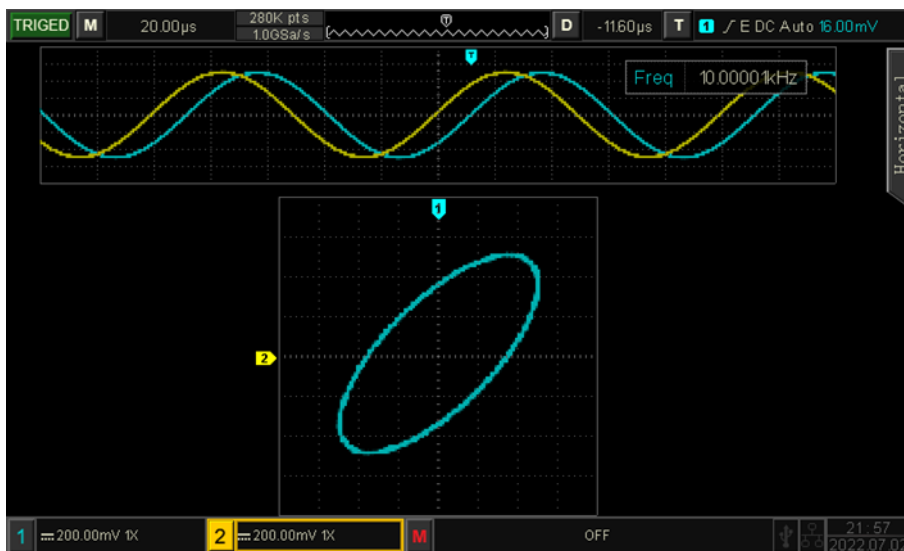

Figure 6-4

Application of XY Mode

Phase difference between in two signals with the same frequency can be easily observed through Lissajous curve. The following figure explains the observation schematic of the phase difference.

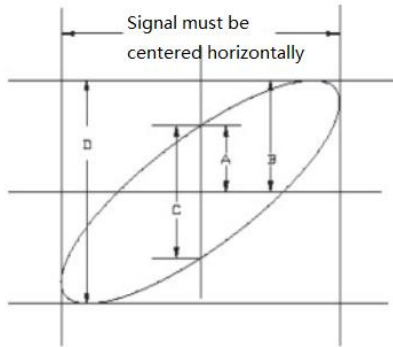

Figure 6-5

Based on $\sin\theta=A/B$ or C/D , θ is the phase angle between channels, the definition of A, B, C, D see Figure 6-5. So the phase angle is $\theta = \pm \arcsin (A/B)$ or $\theta = \pm \arcsin (C/D)$.

If the main spindle of elliptical within I, III quadrant, then the acquired phase angle should at I, IV quadrant, that is within $(0 \sim \pi/2)$ or $(3\pi/2 \sim 2\pi)$.

If the main spindle of elliptical within II, IV, then the acquired phase angle should within $(\pi/2 \sim \pi)$ or $(\pi \sim 3\pi/2)$.

In addition, if the frequency or phase difference of the two signal to be measured are integer times, calculating the frequency and phase relation of the two signals based on the Figure 6-6.

Phase Angle \ Freq ratio	0	$\frac{1}{4}\pi$	$\frac{1}{2}\pi$	$\frac{3}{4}\pi$	π
1:1					
1:2					
1:3					
2:3					

Figure 6-6

6.5 Multi-Scopes

In multi-scopes, CH1, CH2 can be set to different timebase scale, so that signals of different frequency in multiple channels can be observed at the same time. Enter Multi-Scopes interface via horizontal menu.

Switch Multi-scopes to enter this mode, as shown in Figure 6-7. Each channel can be set to different frequency, amplitude and waveform and all can be stable generated in multi-scopes.

In multi-scopes, it can turn on, off, activate channel. Timebase scale, volts/div, horizontal displacement, vertical displacement, trigger setting of channel can be adjusted independently.

Multi-Scopes supports split screen (upper and down screen) for observing waveform, as shown in Figure 6-7.



Figure 6-7

6.6 Trigger Holdoff

Trigger holdoff is used for viewing complicated waveform (such as pulse string). Holdoff time refers to the time that the oscilloscope waits to restart the trigger circuit. During hold off, the oscilloscope will not trigger until the end of holdoff time. For example, a group of pulse string, it requires that trigger the first pulse string and the hold off time can be set as width of pulse string, as shown in Figure 6-8.

In **HORI MENU**, use multipurpose knob and numeric keyboard to set hold off time. Time range: 100 ns ~10 s.

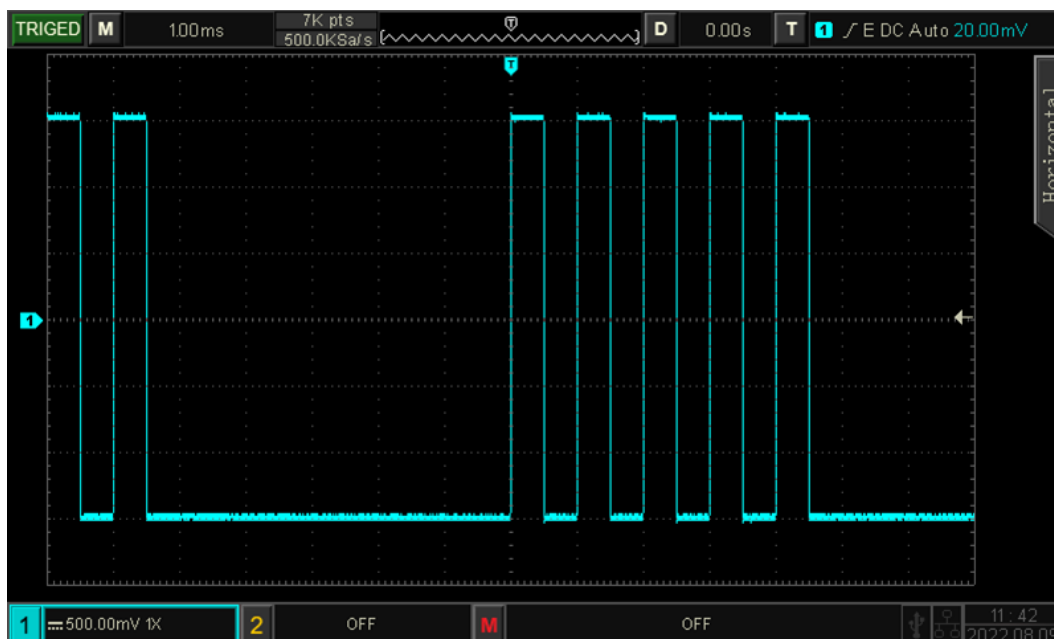

Figure 6-8

7. Trigger System

- 7.1 Noun Explanation of Trigger System
- 7.2 Edge Trigger
- 7.3 Pulse Width Trigger
- 7.4 Video Trigger
- 7.5 Slope Trigger
- 7.6 Runt Trigger
- 7.7 Over-Amplitude Pulse Trigger
- 7.8 Delay Trigger
- 7.9 Time-out Trigger
- 7.10 Duration Trigger
- 7.11 Setup/Hold Trigger
- 7.12 Nth Edge Trigger
- 7.13 Pattern Trigger
- 7.14 RS232 Trigger
- 7.15 I²C Trigger
- 7.16 SPI Trigger
- 7.17 CAN Trigger
- 7.18 LIN Trigger
- 7.19 DECODE

Trigger determines when the oscilloscope starts to collect data and display waveform. Once the trigger is correctly setup, it can convert unstable signals into meaningful waveform. In the beginning of data acquisition, it collects enough data to compose the waveform at the left of the trigger point, and continue to collect the data until the trigger condition is met. When a trigger is detected, the oscilloscope continuously collecting enough data to draw the waveform at the right of the trigger point.

In this chapter, take UPO1202CS as example to introduce trigger setting.

7.1 Noun Explanation of Trigger System

(1) Trigger Source

A signal for generating a trigger. Trigger can be obtained from a variety of information sources, such as input channel (CH1, CH2), external trigger (EXT), mains electricity, etc.

- a. Input channel: Select any one of the analog signal input port CH1~CH2 on the front panel of the oscilloscope as a trigger signal. Trigger level range: ± 5 grids from screen center.
- b. External trigger: Select the input signal EXT TRIG (EXT input port) on the front of the oscilloscope as a trigger signal. For example, the external clock input to EXT Trig port to be a trigger source. EXT signal trigger level within the range from - 4 V~ +4 V can be set.
- c. Mains electricity: Used to observe the related signal of mains electricity, such as the relation of lighting equipment and power supply equipment, to obtain stable synchronization.

(2) Trigger Mode

Trigger mode determines the behavior of the wave during a trigger event. This oscilloscope provides three kinds of trigger modes: auto, normal, and single.

- a. Auto trigger: When there is no trigger signal, the system automatically collect and display data. When the trigger signal is generated, it automatically switch to trigger scanning, so that the signal will be synchronized.

Auto trigger mode is suitable for

- Check DC signal or signal with unknown electrical feature

Note: This mode allows 50 ms/div or in slower timebase scale to set no trigger signal in ROLL mode.

- b. Normal trigger: The oscilloscope can only collect data when the trigger condition is satisfied. When there is no trigger signal, the oscilloscope will stop collect data. When the trigger condition is satisfied, refresh the current waveform data display on the screen, otherwise, it remains the last triggered waveform.

Normal trigger mode is suitable for

- Only collect the specific event appointed by the trigger setting;
 - Rare trigger event, use normal mode can prevent the oscilloscope from automatic trigger, so that the waveform can be stable display.
- c. Single trigger: Delete the waveform display on the screen, the oscilloscope waits for the trigger. When the instrument detects a single trigger, the waveform will be sampled and displayed, and then the instrument enters the STOP state.

Single trigger mode is suitable for

- Capture casual event or aperiodicity signal, such as up, down waveform;
- Rare trigger event

(3) Trigger Coupling

Trigger coupling determines which part of the signal will be transmitted to the trigger circuit. The coupling type includes DC, AC, low frequency/high frequency suppression and noise suppression.

- a. DC: Let all the components of the signal pass through

- b. AC: Block the DC component of the signal
- c. High frequency suppression: Attenuates high frequency components over 40kHz.
- d. Low frequency suppression: Attenuates low frequency components below 40kHz.
- e. Noise suppression: Suppress high frequency noise in the signal to reduce probability of touch error.

(4) Pre-trigger / Delayed Trigger

Before trigger event / after collect data.

Trigger position is usually set at the horizontal center of the screen, user can observe 7 grids of pre-trigger and delay trigger information. Horizontal move the waveform to view more pre-trigger information. By observing the pre-trigger data, the waveform before generated can be observed. For example, capturing the glitch at the start of the circuit, observing and analyzing the pre-trigger data to find out the cause of the glitch.

7.2 Edge Trigger

The edge can be triggered by looking for the specific edge (rising edge, falling edge and random edge) and electrical level. Press edge trigger menu to set signal source, edge type, alternate trigger and trigger mode, waveform can be stable generated when the condition is satisfied, as shown in Figure 7-1.

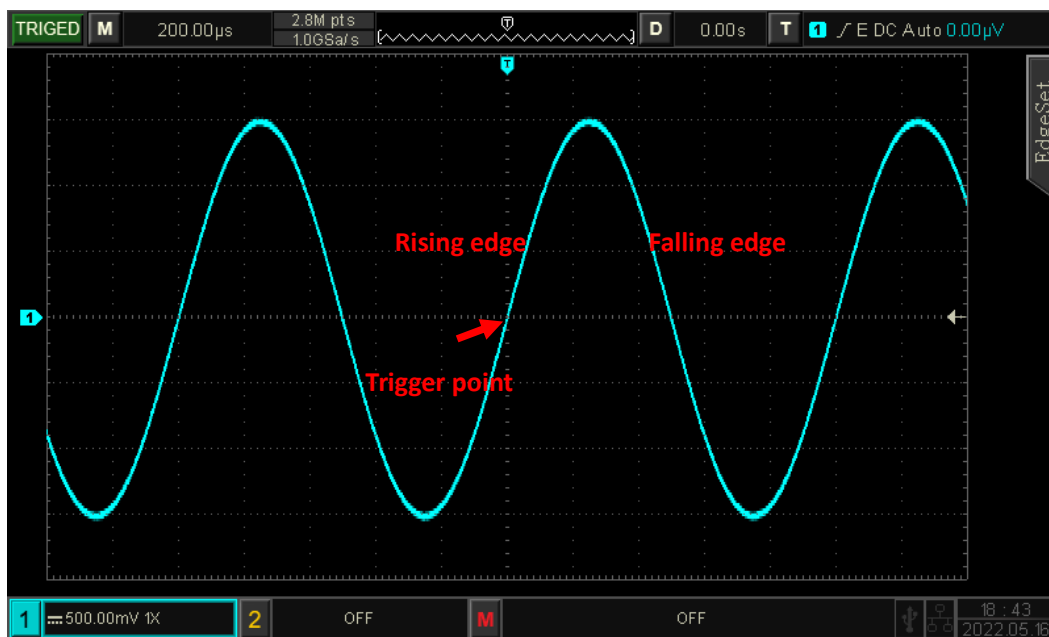

Figure 7-1

(1) Edge type:

- a. Rising edge: Set to trigger on the rising edge of the signal.
- b. Falling edge: Set to trigger on the falling edge of the signal.
- c. Random edge: Set to trigger on the rising edge and the falling edge of the signal.

7.3 Pulse Width Trigger

Pulse width trigger can set the oscilloscope at specific width and generated the positive pulse or negative pulse when meet the trigger condition. Pulse width trigger menu can set information source, polarity of pulse width (positive and negative), condition, the upper /lower limit of time, trigger coupling, trigger mode, etc. As shown in Figure 7-2.

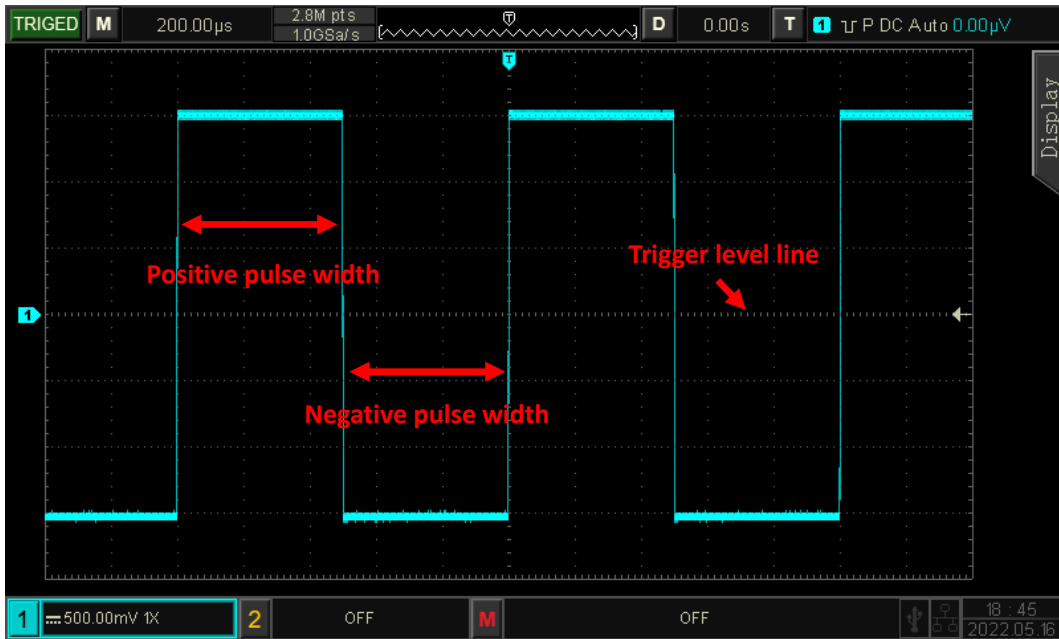

Figure 7-2

(1) Condition

Select trigger condition: “>”, “<”, “ $\leq\geq$ ” .

- >: It will be generated when the pulse width of the trigger signal is greater than the pulse width setting, it can set the lower limit of pulse width.
- <: It will be generated when the pulse width of the trigger signal is smaller than the pulse width setting, it can set the upper limit of pulse width.
- $\leq\geq$: It will be generated when the pulse width of the trigger signal is in the setting scope, it can set the lower limit of pulse width and the upper limit of pulse width.

(2) The upper /lower limit of time

Compare the setting pulse width value with the signal pulse width. The trigger will be generated when the condition is met. The range can be set to 2 ns ~10 s.

7.4 Video Trigger

The video signal includes the image and the time sequence information, it has multiple standards and formats. UPO1000CS provides the basic measurement functions, which can be triggered in NTSC (National Television Standards Committee), PAL (Phase Alternating Line), SECAM (Sequential Couleur A Memoire).

(1) Video Format

- a. PAL: The frame frequency is 25 frames per second, the TV scan line is 625 lines, the odd field is in the front and the even field is in the rear.
- b. NTAC: The field frequency is 60 fields per second, and the frame frequency is 30 frames per second. The TV scan line is 525 lines. The even field is in the front and the odd field is in the rear.
- c. SECAM: The frame frequency is 25 frames per second, the TV scan line is 625 lines, interlaced scanning.

(2) Video Synchronization

- a. Even field: Set to trigger and synchronize on the even field of the video signal.
- b. Odd field: Set to trigger and synchronize on the odd field of the video signal.
- c. All lines: Set to trigger and synchronize on the line signal of the video signal.
- d. Specified lines: Set to trigger and synchronize on the specified video lines. User can use the Multipurpose knob to specify the line number, and the setting range is from 1 to 625 (PAL/SECAM), or from 1 to 525 (NTSC).

Note: In order to observe the waveform details in the video signal, user can set the memory depth a little bigger.

The UPO1000CS series utilize the UNI-T original digital 3D technology, it uses a multi-level grayscale display function so that different brightness can reflect the frequency of different parts of the signal. Experienced users can quickly judge the signal quality during the debugging process and find the unusual conditions.

7.5 Slope Trigger

Slope trigger refers to triggering when the slope of signal rising or falling conforms to the set value. Slope trigger menu can set the source, trigger coupling, trigger mode, slope (positive slope, negative slope), condition, the lower limit/ upper limit of time, threshold, etc.

(1) Slope

- a. Positive slope: Perform slope trigger by using the rising edge of the trigger signal.
- b. Falling slope: Perform slope trigger by using the falling edge of the trigger signal.

(2) Condition

- a. $>$: It will be generated when the slope time of the trigger signal is greater than the setting slope time, it can set the lower limit of time.
- b. $<$: It will be generated when the slope time of the trigger signal is less than the setting slope time, it can set the upper limit of time.
- c. $\leq \geq$: It will be generated when the slope time of the trigger signal is within the scope of setting slope time, it can set the lower/upper limit of time.

Note: Slope time of trigger signal refers to the figure shown “slope time of rising/ falling edge”.

(3) Threshold

Threshold has three mode: low level, high level and high-low level. Press LEVEL knob to quickly select the mode.

- a. Lower level: The slope of the low threshold level can be adjusted with the LEVEL knob.
- b. High level: The slope of the high threshold level can be adjusted with the LEVEL knob
- c. High-low level: The slope of the high-low threshold level can be adjusted with the LEVEL knob

(4) The lower/upper limit of time

Set the time of slope, range can be set to 8ns ~ 10s.

Note: The formula for calculating the slew rate is

(High level threshold - Low level threshold) ÷ Time

For the set slew rate, the time here is the time setting value. For the slew rate of the trigger signal, the time here refers to the time value between two intersection points where the high level, low level intersect with the trigger signal.

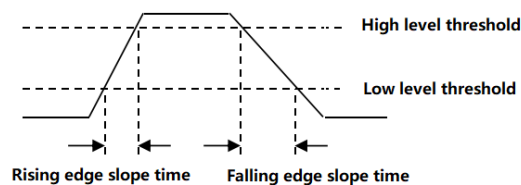

7.6 Runt Trigger

The runt trigger is used to trigger a pulse that has crossed one trigger level but not the other.

In this oscilloscope, the positive runt pulse is the pulse that crosses the lower limit of the trigger level but does not cross the upper limit of the trigger level; the negative runt pulse is the pulse that crosses the upper limit of the trigger level but does not cross the lower limit of the trigger level, as shown in Figure 7-3..

The runt trigger menu can set source, trigger coupling, trigger mode, polarity (positive, negative pulse), runt condition (irrelevance, $<$, $>$, $\leq \geq$), time setting (the lower/upper limit of time), trigger level, etc.

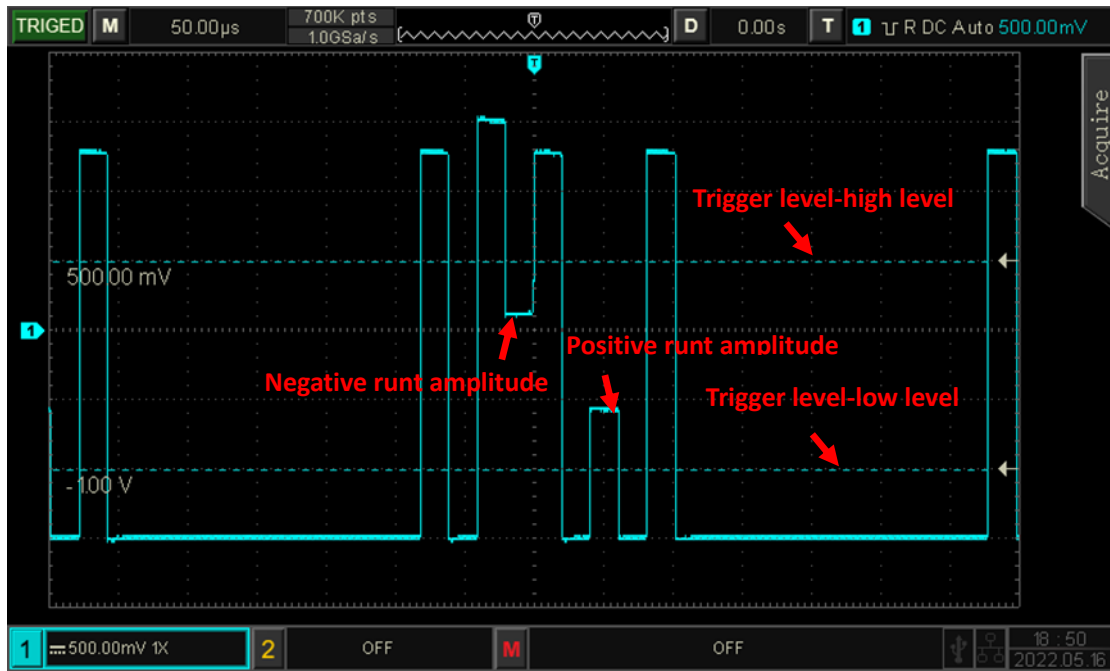

Figure 7-3

- (1) Polarity
 - a. Positive pulse: Set to trigger on the positive runt pulse.
 - b. Negative pulse: Set to trigger on the negative runt pulse.

- (2) Condition

Trigger condition: Irrelevance, $>$, $<$, \leq , \geq .

 - a. Irrelevance: Does not set the runt pulse trigger condition.
 - b. $>$: It will be generated when the runt pulse width is greater than the setting pulse width, it can set the lower limit of time.
 - c. $<$: It will be generated when the runt pulse width is less than the setting pulse width, it can set the upper limit of time.

- (3) \leq , \geq : It will be generated when the runt pulse width is in the scope of the setting pulse width or within a range, it can set the lower/upper limit of time

- (4) The lower/upper limit of time

Compare the setting pulse width value with pulse width of channel. It will generated when trigger condition is met, range can be set to 8ns ~ 10s.

7.7 Over-Amplitude Pulse Trigger

Trigger level of over-amplitude has a high level and a low level, when the rising edge of the input signal crosses the high level or the falling edge crosses the low level, the oscilloscope will be triggered, as shown in Figure 7-4. Over-amplitude pulse trigger menu can set to source, coupling mode, trigger mode, slope (rising edge, falling edge, random edge), position (enter, exit, time), setting, trigger level, etc.

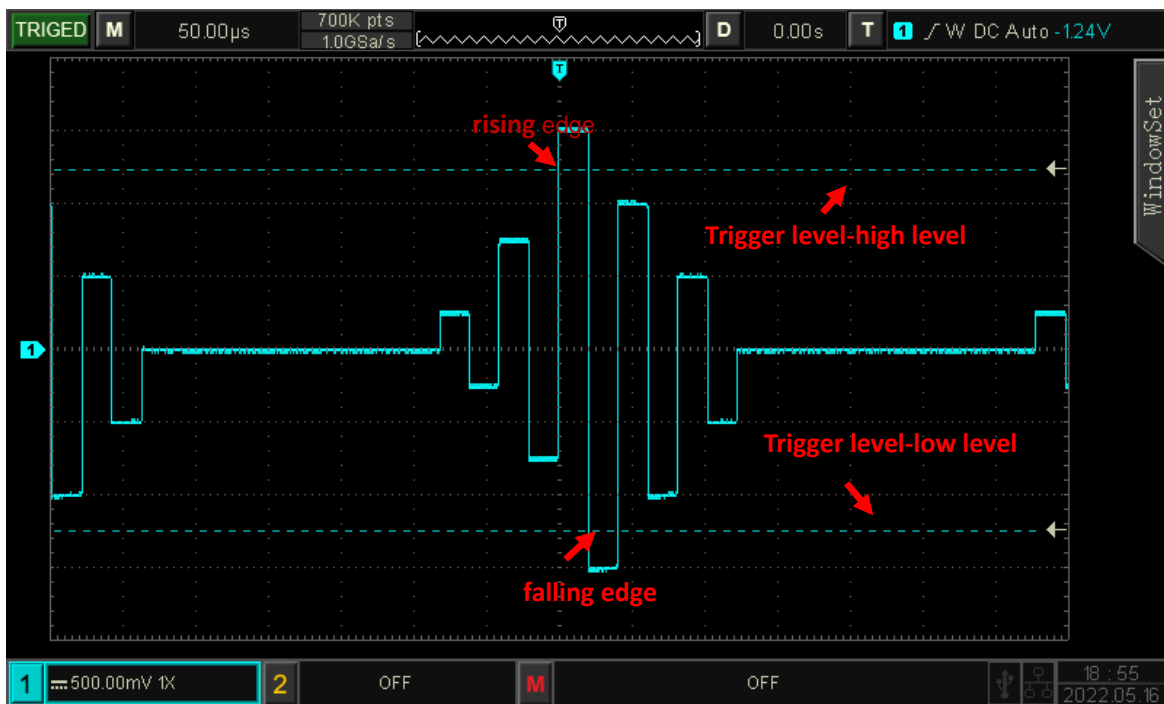

Figure 7-4

(1) Slope

Select which edge that the input signal can be triggered. It can select rising edge, falling edge or random edge. The current slope is displayed in the upper right corner of the screen.

- a. Rising edge: It will be generated when the trigger on the rising edge of the input signal and the voltage level is higher than the setting high level.
- b. Falling edge: It will be generated when the trigger on the falling edge of the input signal and the voltage level is lower than the setting low level.
- c. Random edge: It will be generated when the trigger on the rising/falling edge of the input signal and the voltage level is within the setting level.

(2) Trigger Position

Trigger position can set enter, exit and time. Select trigger position to confirm the timing of trigger.

- a. Enter: It will be generated when the input signal enter the specified trigger level.
- b. Exit: It will be generated when the input signal exit the specified trigger level.
- c. Time: It will be generated when the over-amplitude entered, accumulated hold time is greater than or equal to the preset over-amplitude time

(3) Setting

When trigger position is set to “Time”, the setting time takes effect and is triggered when condition is met. The range can be set to 8ns ~ 10s.

7.8 Delay Trigger

Delay trigger should set trigger source 1 and trigger source 2. When the time difference (ΔT) between the edge set by source 1 (edge 1) and the edge set by source 2 (edge 2) meets the preset time limit, the oscilloscope is triggered, as shown in Figure 7-5.

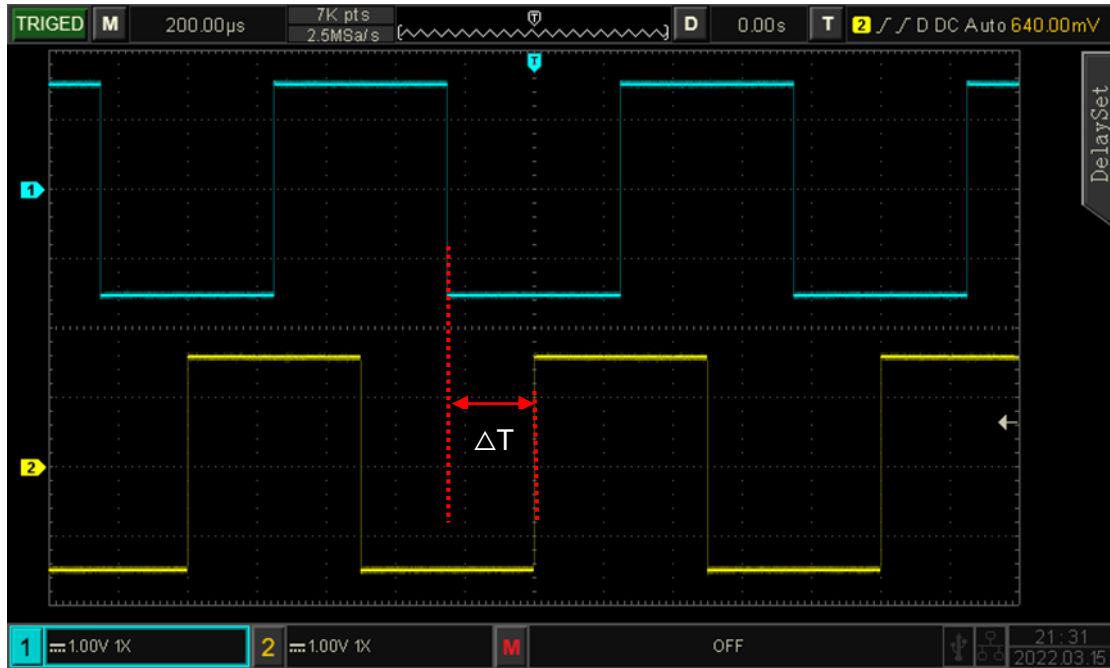

Figure 7-5

Edge 1 set as rising edge, edge 2 also set as rising edge. ΔT is the area marked by red color, as shown in Figure 7-5.

Note: Edge 1 and edge 2 must be adjacent edges.

Note: Only the channel that has been connected to the signal, select it as the trigger source that can get the stable trigger.

(1) Condition

Set delay condition to $>$, $<$, $<>$, $\leq\geq$, $><$.

- $>$: It will be generated when the time difference (ΔT) between the edge of source 1 and the edge of source 2 is greater than the setting lower limit of time, it can set the lower limit of time.
- $<$: It will be generated when the time difference (ΔT) between the edge of source 1 and the edge of source 2 is smaller than the setting upper limit of time, it can set the upper limit of time.
- $\leq\geq$: It will be generated when the time difference (ΔT) between the edge of source 1 and the edge of source 2 is greater than the setting lower limit of time and smaller than the setting upper limit of time, it can set the upper limit and lower limit of time.
- $><$ (irrelevance): It will be generated when the time difference (ΔT) between the edge of source 1 and the edge of source 2 is smaller than the setting lower limit of time or greater than the setting upper limit of time. It can set the upper limit and lower limit of time.

(2) The upper/lower limit of time

Compare the setting time value with ΔT , it will be triggered when the condition is met. The range can be set 8ns ~ 10s.

7.9 Time-out Trigger

Timeout trigger can generate the signal when the time interval (ΔT) from the rising edge (or falling edge) of the input signal to adjacent falling edge (rising edge) across the trigger level is greater than the set timeout time. As shown in Figure 7-6.

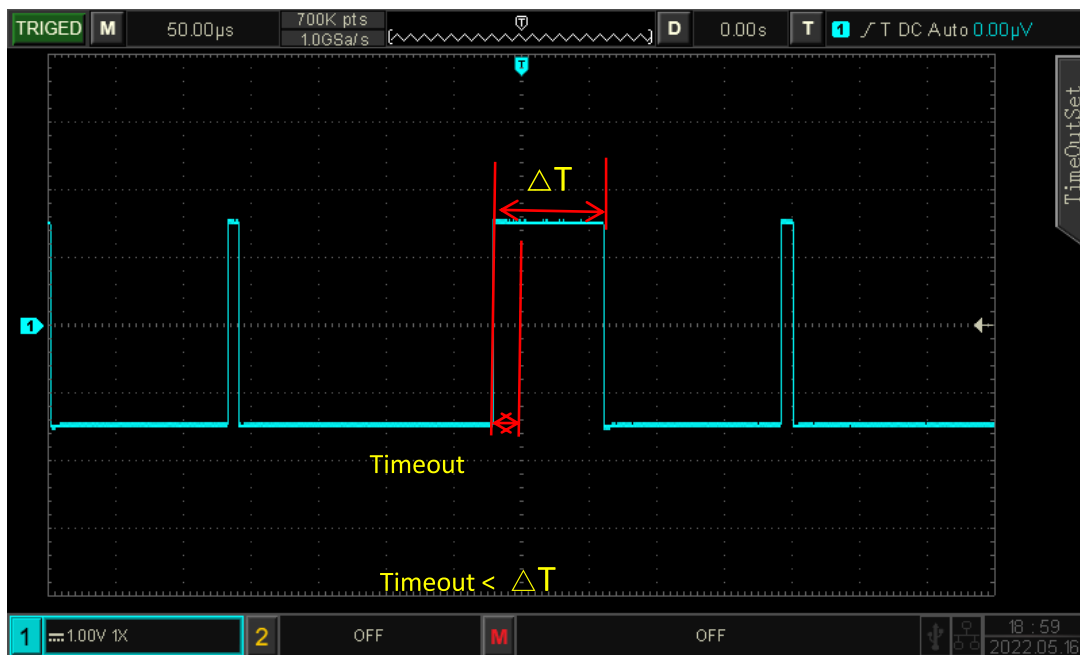

Figure 7-6

(1) Slope

Select which edge that the input signal can be triggered. It can select rising edge, falling edge, random rising. The current slope is displayed in the upper right corner of the screen.

- Rising edge: Set the timer to start when the rising edge of the input signal through the trigger level.
- Falling edge: Set the timer to start when the falling edge of the input signal through the trigger level.
- Random edge: Set the timer to start when the rising edge or the falling edge of the input signal through the trigger level.

(2) Timeout

Compare timeout with ΔT , it will be triggered when the condition is met. The range can be set 8ns ~ 10s.

7.10 Duration Trigger

With duration trigger selected, the oscilloscope identifies the trigger condition by looking for the duration of the specified codes. The codes are the combination of channel logic "AND", and the value of each channel can be H (high), L (low), or X (ignored). When the duration (ΔT) of the code meets a preset time, it will be generated, as shown in Figure 7-7.

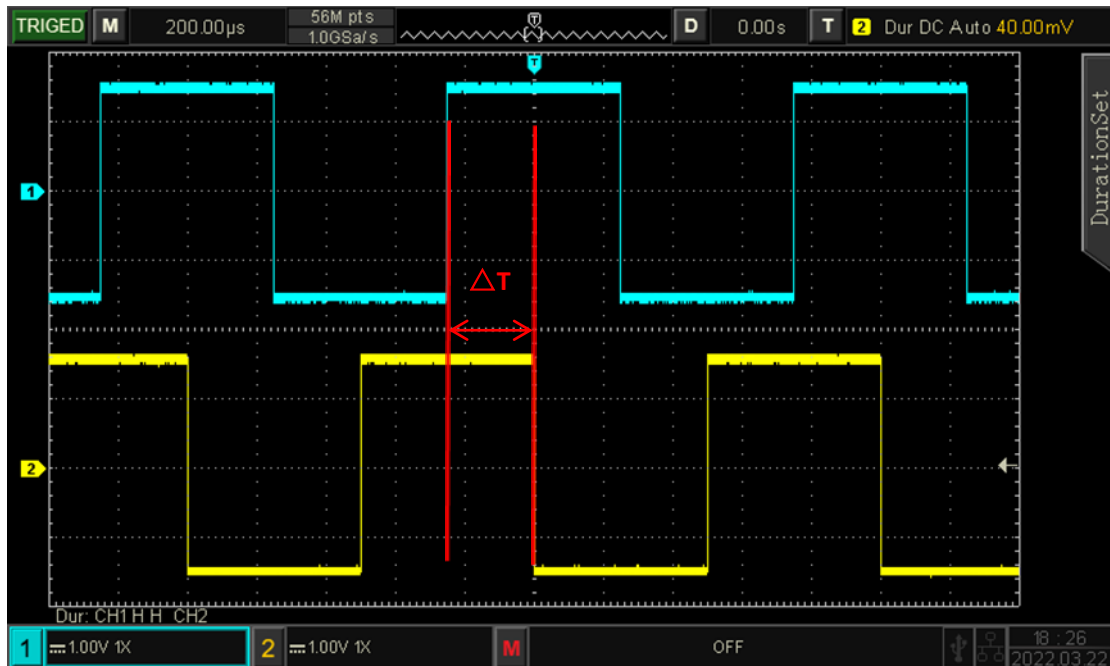

Figure 7-7

(1) Code

It has three modes H, L and X. The code setting of each channel is displayed at the bottom of the screen, as shown in Figure 7-7.

- H: Set the code value of the selected channel to "High", that is, the voltage level is higher than the trigger level of the channel.
- L: Set the code value of the selected channel to "Low", that is, the voltage level is lower than the trigger level of the channel.
- X: Set the code value of the selected channel to "Ignored", that is, the channel is not part of the codes. The oscilloscope will not trigger if all channels in the codes are set to "ignored".

(2) Condition

Press the condition key to select: $>$, $<$, \leq , \geq .

- $>$: It will be generated when the code duration is greater than the setting time, it can set the lower limit of time.
- $<$: It will be generated when the code duration is small than the setting time, it can set the upper limit of time.

- c. $\leq \geq$: It will be generated when the code duration is small than the setting upper time limit and greater than the setting lower time limit, it can set the upper limit and the lower limit of time.
- (3) The upper/lower limit of time
 Compare the duration time with the setting time of ΔT , it will be triggered when the condition is met. The range can be set to 8ns ~ 10s.

7.11 Setup/Hold Trigger

In setup/hold trigger, the oscilloscope need to set up the data signal line and clock signal line. The setup time begins when the data signal crosses the trigger level and ends when the specified clock edge arrives. The hold time begins when the specified clock edge arrives and ends when the data signal crosses the trigger level again (as shown in Figure 7-8). The oscilloscope will trigger when the setup time or the hold time is less than the preset time. It is mainly used to locate and find error code, and quickly find the signal that cannot meet setup hold time.

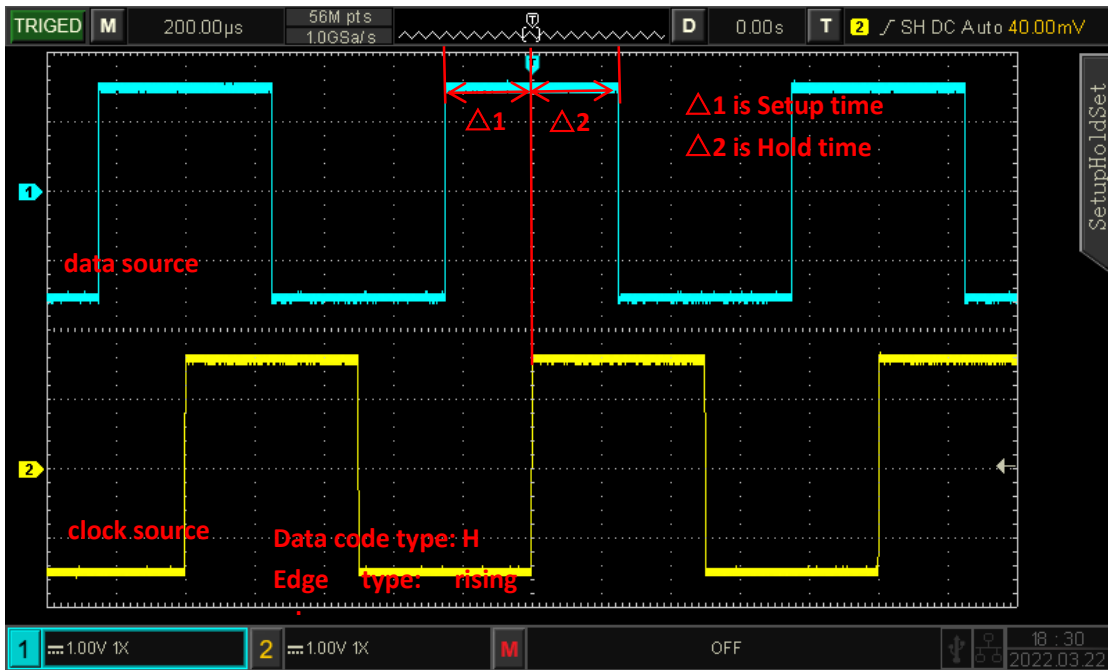

Figure 7-8

- (1) Pattern
 It has two modes H and L.
- a. H: Set the valid code of the data signal to high level.
 - b. L: Set the valid code of the data signal to low level.
- (2) Clock edge
 Select the clock edge type: rising edge and falling edge.
- a. Rising edge: Set the clock edge type to rising edge.
 - b. Falling edge: Set the clock edge type to falling edge.

(3) Setup/Hold

It has three modes setup, hold, setup & hold.

- Setup: It will be generated when the setup time is small than the setting value.
- Hold: It will be generated when the setup time is small than the setting value.
- Setup & hold: It will be generated when the setup time and the hold time are all small than the set value.

(4) Time

Compare the setup, hold time of code with the setting time of ΔT , it will be triggered when the condition is met. The range can be set 8ns ~ 10s.

7.12 Nth Edge Trigger

The Nth edge trigger is triggered on the Nth edge after the specified idle time. For example, as shown in Figure 7-9, it is set to trigger on the 2nd rising edge after the specified idle time (the time between two adjacent rising edge), then set the idle time as $P < \text{idle time} < M$, M is the time between the 1st rising edge and the next rising edge, P is the maximum time between the counting rising edge,

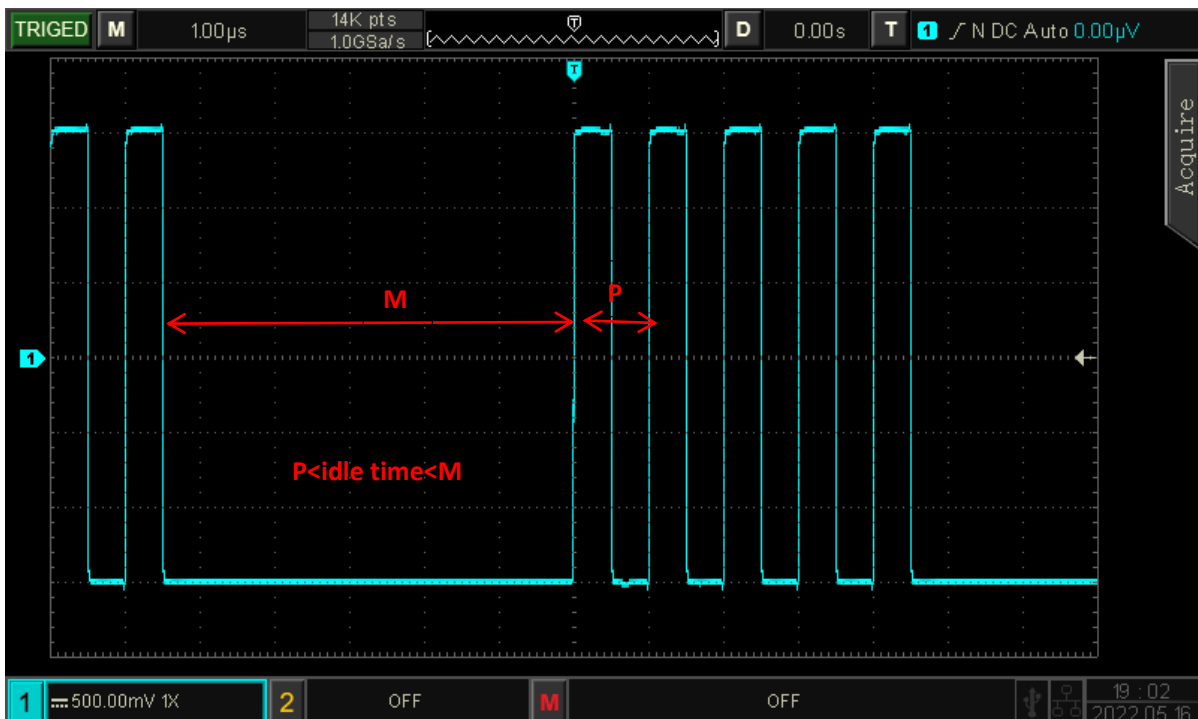

Figure 7-9

(1) Slope

Select which edge that the input signal can be triggered. It can select rising edge, falling edge. The current slope is displayed in the upper right corner of the screen.

- Rising edge: Set to trigger on the rising edge of the signal.
- Falling edge: Set to trigger on the falling edge of the signal.

(2) Idle Time

Compare the idle time with pulse time, it will be triggered when the condition is met. The range can be set 8ns ~ 10s.

(3) Edge Value

The edge value is triggered at the edge of the pulse string. The edge value can be set by using multipurpose knob, shuttle knob and numeric keypad. The edge value range can be set 1 to 65535.

7.13 Pattern Trigger

The pattern trigger identifies the trigger condition by looking for the specified patterns. The pattern trigger type is the combination of the channel logic "AND", each channel can be set to H (high), L (low), X (ignored). You can also specify a channel in the type as a rising edge or falling edge (only one edge can be specified). When the edge is assigned, if the pattern of the other channels are judged "true" (i.e., the actual code is consistent with the preset code type), the oscilloscope will trigger on the specified edge. If the edge is not assigned, the oscilloscope will trigger at the last edge of the code type "true". If the pattern of all channels are set to "ignore", the oscilloscope will not be triggered.

(1) Pattern

There are H, L, X, rising edge, or falling edge. The pattern setting of each channel is displayed at the bottom of the screen.

- a. H: Set the pattern value of the selected channel to "High", that is, the voltage level is higher than the trigger level of the channel.
- b. L: Set the pattern value of the selected channel to "Low", that is, the voltage level is lower than the trigger level of the channel.
- c. X: Set the pattern value of the selected channel to "Ignored", that is, the channel is not part of the pattern. The oscilloscope will not be triggered if all channels in the pattern are set to "ignored".
- d. Rising edge: Set the pattern to the rising edge of the selected channel.
- e. Falling edge: Set the pattern to the falling edge of the selected channel.

7.14 RS232 Trigger

RS232 interface is an asynchronous transmission standard interface developed by the Electronics Industry Association. It is usually available in DB-9 or DB-25 applications. It is suitable for communication with data transmission rate in the range of 0~25000000b/s and is widely used in microcomputer communication interface. The data to be sent is combined into a specific set of serial bits according to the protocol rules and sent in an asynchronous serial.

The data sent each time is according to the following rules: send one start bit firstly, then 5 to 8 is data bits, the next is optional parity bits, and the last is one or two stop bits. The number of data bits is agreed upon by the two communicating parties and can be 5 to 8 bits, no parity bits, or select odd or even parity. Stop bit can select one or two bits. In the following description, one data string transmission is referred to as one frame, as shown in figure below,

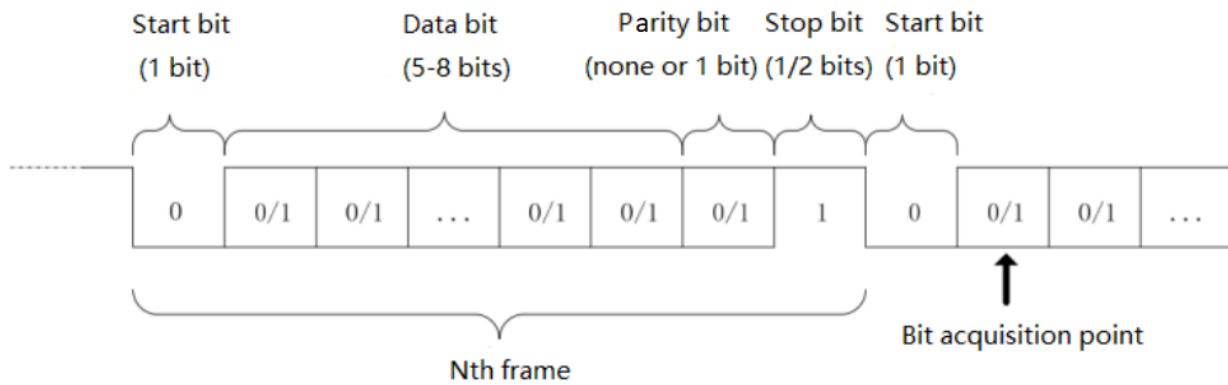

(1) Information Source

The information source which is trigger source, CH1 and CH2 can be selected. The current selected source will displayed in the upper right corner of the screen.

Note: Only the channel that has been connected to the signal, select it as the trigger source that can get the stable trigger and correct decoding.

(2) Baud Rate

When RS232 is asynchronous transmission communication, there is no accompanying clock signal during data transmission. In order to solve the determination of data bits, the protocol stipulates that both parties of communication should agree on the bit rate. Usually, the bit rate is defined as the number of bits that can be transmitted in 1s. For example, 9600 bps means 9600 bits can be transmitted in 1s. Note that the start, data, parity and stop bits are all counted as bit, so the baud rate does not directly equal the effective data rate. The oscilloscope will sample the bit values according to the setting baud rate.

Baud rate can choose 2400 bps, 4800 bps, 9600 bps, 19200 bps, 38400 bps, 57600 bps, 115200 bps, 128000 bps, 230400 bps, 460800 bps, 921600 bps, 1382400 bps, 1843200 bps, 2764800 bps and user-defined. The baud rate can be adjusted via the Multipurpose knob or jog dial when user-defined is selected.

It is recommended to set the baud rate based on the hardware and software of RS232 communication protocol. Due to the basic model of this transmission protocol, RS232 protocol is usually used for short distance (under 20m) and low speed (under 1 Mbps) transmission. Communication beyond this range is susceptible interference and unreliable.

(3) Polarity

Press the Polarity key to select the trigger polarity: positive and negative polarity.

- a. Negative polarity: opposite logic level polarity, i.e. high level is 0 and low level is 1.
- b. Positive polarity: normal logic level polarity, i.e. high level is 1, low level is 0.

(4) Bit Width

Specify the data bit width of RS232 protocol signal to be decoded, 5 bits, 6 bits, 7 bits, 8 bits can be selected.

(5) Bit Order

Specify whether the data bits of the RS232 protocol signal to be decoded are high bit first (MSB) or low bit first (LSB), and either MSB or LSB can be selected.

- a. MSB: The high bit of data is transmitted first.
- b. LSB: Data low bit is transmitted first.

(6) Stop Bit

The stop bit is the bit that sets the stop after each data frame. It can be set to 1 bit or 2 bits.

(7) Parity

Set the parity mode of data transmission. It can select no parity, even parity or odd parity.

(8) Trigger Condition

The trigger condition is to set the trigger condition, it can choose start frame, error frame, parity error and data.

- a. Start frame: Waveform triggering at the start bit of RS232 protocol. When send a single string or send the same string several times, this trigger can be used to see a stable signal waveform, and if the sent data changes, the corresponding waveform will also be change.
- b. Error frame: When receiving 0 in the stop state or data error occurs in the middle of data bits.
- c. Parity error: RS232 protocol sets the parity bit to 0 or 1 according to the parity rule when there is a parity bit setting.

The parity rule is as follows.

Odd parity: If in data bits and parity bits, number of bit 1 is odd, then the transmission is correct.

Even Check: If in data bits and parity bits, number of bit 1 is even, then the transmission is correct.

Using this option, user can check the RS232 communication process and quickly find the transmission process of parity error, so that you can easily locate the fault analysis.

- d. Data: The trigger is generated when the data acquired by the oscilloscope is the same as the 2-bit hexadecimal number set by the user. Using this option, user can quickly find the transmission signal of the specific data you are interested in.

(9) Data

It will be valid when the trigger condition is "Data", settable range: 00 ~ FF (hexadecimal number).

7.15 I²C Trigger

I²C trigger usually used to connecting microcontroller and peripheral equipment, it's widely applied in micro-electronics area. This bus protocol has two lines to transmit, one line is serial data SDA, and another line is serial clock SCL. Communicated by master-slave system which can both-way communication between master and slave computer. The bus is a multiple master bus that prevents data corruption through conflict detection and arbitration mechanisms. It is worth noting that the I²C bus has two address bit widths, 7 bits and 10 bits, where 10 bits and 7 bits addresses are compatible that can be used in combination. When the bus is idle, both lines are high level. When any device on the bus output low level, it will make the bus signal goes low, i.e., the signals of multiple devices are "wired and" logic. This special logic relation is the key to bus arbitration. The protocol requires that the data SDA must remain stable while the clock line SCL is high, and the data is usually transmitted in MSB form. This is shown in the following diagram.

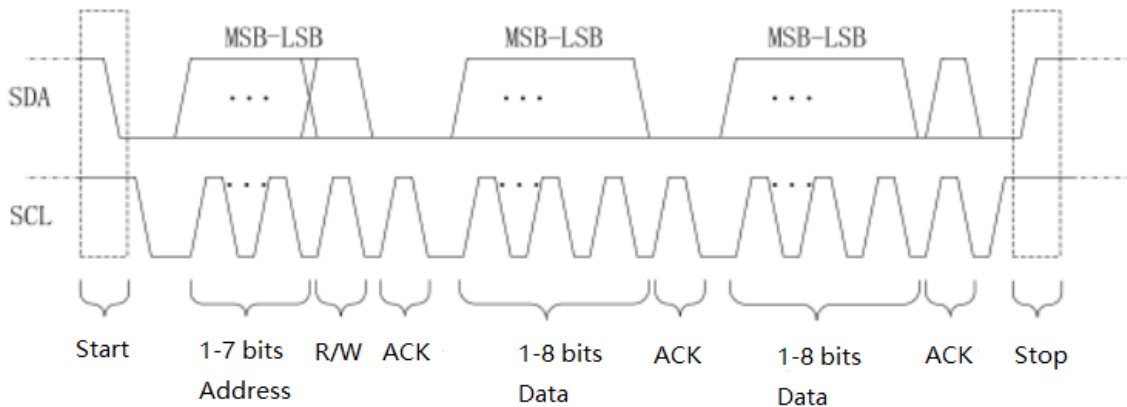

I²C trigger can set SCL source, SDA source, operating direction, trigger condition, address setting and data setting.

(1) SCL Source

When SCL source is selected, it can set either CH1 or CH2 as the clock input of I²C.

(2) SDA Source

When SCL source is selected, it can set either CH1 or CH2 as the data input of I²C.

(3) Operating Direction

It can set to "write, read or random"

a. Write: It will be generated when the "read/write" bit of the I²C protocol is "write".

b. Read: It will be generated when the "read/write" bit of the I²C protocol is "read".

c. Random: It will be generated the "read/write" bit of the I²C protocol is "read or write".

(4) Trigger Condition

It can set the I²C trigger condition to start, restart, stop, loss confirmed, address, data and address data.

- a. Start: It will be generated at the start time, that is, when the SCL is in high level, the SDA signal has a falling edge.
- b. Restart: It will be generated at the restarting time, that is, after a start signal, and before it stops, the start signal appears again.
- c. Stop: It will be generated when the stop bit occurs, that is, when the SCL is in high level, the SDA signal jumps from low to high.
- d. Loss Confirmed: In I²C protocol, every time after 8 bits of information are transmitted, the data receiver needs to send an acknowledgement signal, which is the ACK bit in the above figure when the SCL is in high level, the SDA signal is low. The loss trigger will occur while the SCL and SDA signal at the ACK bit are both high.
- e. Address: It will be generated when the communication address is the same with the user setting address. It can help to quickly locate the address transmission.
- f. Data: It will be generated when the detected data is equal to/ greater than/ less than/ not equal to the setting value. This feature is convenient for the data analysis and can capture the abnormal data.
- g. Address & Data: It will be generated when the addresses are the same and the data relationship meets the setting conditions during the transmission process. This trigger condition makes it easy to implement the I²C specified address and data trigger, and help to analyze the transmission.

(5) Address Setting

a. Address Bit Wide

When the trigger condition is select “address” or “address data”, it should set the address bit wide to 7bits or 10bits.

b. Address

It will be valid when the trigger condition is “address” or “address data”, the range can set to 00 ~ 3FF (hexadecimal number).

(6) Data Setting

a. Length of Byte

It will be valid when the trigger condition is “address” or “address data”, it can set the specific length of byte, the range can be 1~5.

b. Data

It will be valid when the trigger condition is “address” or “address data”, the range can set to 00~FFFFFFFF (hexadecimal number). Press multipurpose knob to set the data.

c. Data Mask

It can set the data mask value.

7.16 SPI Trigger

SPI (serial peripheral interface) can connect the host with peripheral equipment in serial way to communication. It's full duplex and synchronous communication bus. It's usually use 4 signal connecting line, MOSI: master data output, slave data input; MISO: master input, slave data output; SCLK: clock signal generated by master; CS: chip select enable signal from slave.

SPI interface is mainly used for synchronous serial data transfer between the host and low-speed peripheral equipment. Under the shift pulse of the host, the data is transferred bit by bit, the high bit in front and behind is the low bit. SPI interface is widely used because it does not require slave address addressing, which is full duplex communication and the protocol is simple. SPI protocol transfer is shown in the following figure,

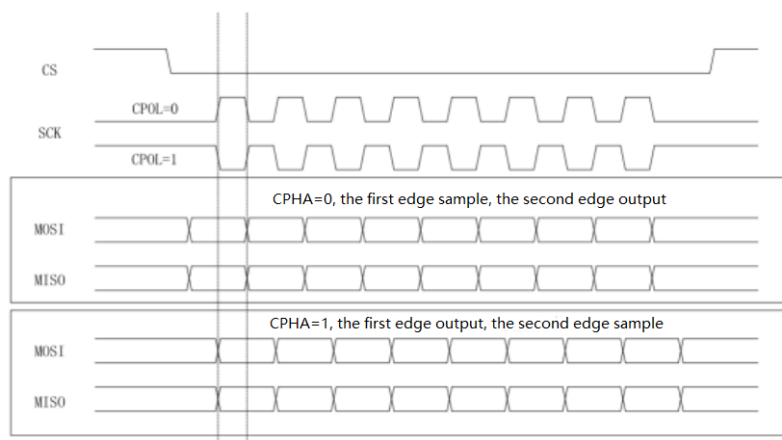

- (1) SCL Source
When SCL source is selected, it can set either CH1 or CH2 as the clock input of SPI decoding signal.
- (2) MOSI Source
When MOSI source is selected, it can set either CH1 or CH2 as MOSI input of SPI decoding signal.
- (3) MISO Source
When MISO source selected, it can set either CH1 or CH2 as MISO input of SPI decoding signal.
- (4) SCLK Polarity
SCLK edge, set the edge of clock signal: rising edge, falling edge.
 - a. Rising edge: triggered on the rising edge of the clock signal.
 - b. Falling edge: triggered on the falling edge of the clock signal.
- (5) MOSI Polarity
It can set MOSI polarity of data signal: positive / negative polarity.
 - a. Positive: It is 1 when setting signal is greater than the threshold, otherwise it is 0.
 - b. Negative: It is 1 when setting signal is small than the threshold, otherwise it is 0.
- (6) MISO Polarity
It can set MISO polarity of data signal: positive / negative polarity.

- a. Positive: It is 1 when setting signal is greater than the threshold, otherwise it is 0.
- b. Negative: It is 1 when setting signal is small than the threshold, otherwise it is 0.

(7) Bit Sequence

Bit sequence is to set whether the data bit of the SPI protocol signal is high order first (MSB) or low order first (LSB).

- a. MSB: high order data transmit first
- B. LSB: low order data transmit first

(8) Bit Wide

Set bit wide of each frame of the SPI protocol signal, which can range from 4 to 32.

(9) Trigger Condition

Set SPI condition which has two types: "idle & data" and "idle".

- a. Idle & data: It will be generated at the edge where the level jumps from invalid to active.
- b. Idle: Idle trigger is generated at the start of a new segment of data after a certain idle time

(10) Idle time

The idle time counter counts when the SCK is unchanged, and judges whether the count value exceeds the preset value at the SCK valid edge, if it exceeds, it will be generated at the valid edge. The counter will be cleared when each clock edge is valid. The range can set to 80ns ~ 1s.

(11) Frame Length

Set the length of data unit, the range can set from 1 to 32.

(12) MOSI Data

MOSI data setting is related to frame length, the range can set to 0 ~ FFFFFFFFFFFFFFFFFFFFFFFFFFFFFFFF.

7.17 CAN Trigger

(1) Information Source

The information source which is select CAN protocol trigger source, CH1 and CH2 can be selected. The current selected source will displayed in the upper right corner of the screen.

(2) Signal Type

Set the input signal of the current source whether is high data line signal or low data line signal, which can select CAN_H and CAN_L.

(3) Trigger Condition

It can set the CAN trigger condition to start frame, data frame, remote frame, error frame, overload frame, identifier, data, ID and data, end of frame, loss confirmed and bit stuff error.

- a. Start Frame: the oscilloscope will generate waveform trigger on start frame.
- b. Data Frame: the oscilloscope will be generate on data frame match with CAN signal.
- c. Remote Frame: it will be generated on remote frame.
- d. Error Frame: the oscilloscope will be generated on error frame of CAN signal.
- e. Overload Frame: the oscilloscope will be generated on overload frame of CAN signal.
- f. Identifier: the oscilloscope will be generated on data frame that matches the specified ID.
- g. Data: the oscilloscope will be generated on data frame that matches the specified ID. // (data frame and remote frame have ID, data frame has data, remote frame has no data.)
- h. ID and Data: the oscilloscope will be generated on data frame that matches the specified ID.
- i. End of Frame: it will be generated on the end of frame of CAN signal.
- j. Loss Confirmed: it will be generated on loss confirmed of CAN signal.
- k. Bit stuff error: in the segment that requires bit filling, the waveform will be triggered when continuous detect the error from the same level of 6 bits.

(4) ID Setting

It can be set when trigger condition is "Identifier" or "ID and data", it can set frame format, ID and direction.

- a. Frame Format: it can set "standard format, extension format", ID value range of different frame format is different.
- b. ID: set the ID value, which can set to 000~7FF, 00000000~1FFFFFFF.
- c. Direction:
 - Write: It will be generated when the "read/write" bit of the CAN protocol is "write".
 - Read: It will be generated when the "read/write" bit of the CAN protocol is "read".
 - Write or Read: It will be generated the "read/write" bit of the CAN protocol is "write or read".

(5) Data Setting

It can be set when trigger condition is "data" or "ID and data", it can set length of byte and data.

- a. Length of byte: set the byte number of data to be triggered, which can set to 1~8.
- b. Data: set the data to be triggered, the settable data byte is related with byte value, which can set to 00~FFFFFFFFFFFFFFFF.

(6) Bit Rate (bps)

Select the bit rate of CAN bus serial data, which can set to 10k, 20k, 25k, 31.25k, 3.3k, 37k, 50k, 62.5k, 68.266k, 83.3k, 92.238k, 100k, 125k, 153k, 250k, 400k, 500k, 800k, 1M and user-defined. User-defined can input custom bit rate value.

7.18 LIN Trigger

- (1) Information Source
The information source which is select CAN protocol trigger source, CH1 and CH2 can be selected. The current selected source will displayed in the upper right corner of the screen.
- (2) Polarity
Set the polarity if input signal, which can set to normal (high=1), reverse (high=0).
- (3) Version
Version can set to v1.x, v2.x and random.
- (4) Bit Rate
Set the bit rate of LIN protocol, which can set to 1.2k, 2.4k, 4.8k, 9.6k, 10.417k, 19.2k and user-defined. User-defined can input custom bit rate value.
- (5) ID include parity bit
It can set to yes or no. when “yes” is selected, the parity bit and ID is included; “no” is not include.
- (6) Trigger Condition
It can set the LIN trigger condition to synchronization, identifier, data, ID and data, wake-up frame, sleep frame and error.
 - a. Synchronization: the oscilloscope will be generated when detect the synchronizing signal.
 - b. Identifier: the oscilloscope will be generated when detect ID is equal to the setting frame.
 - c. Data: Waveform will be generated when the sampled data by LIN protocol is in accord with user setting data. It can help to find the specific data of transmission signal quickly that interest to user.
 - d. ID and Data: the oscilloscope will be generated when detect ID is equal to the setting frame.
 - e. Wake-up Frame: the oscilloscope will be generated on wake-up frame of signal.
 - f. Sleep Frame: the oscilloscope will be generated on sleep frame of signal.
 - g. Error Frame: the oscilloscope will be generated on error frame of LIN signal, which includes synchronizing error, ID parity error and checksum error.
- (7) ID Setting
It can be set when trigger condition is “identifier” or “ID and data”, ID can be set.
 - a. ID: set the ID value
When ID include parity check is set to “yes”, ID range can set to 00~FF.
When ID include parity check is set to “no”, ID range can set to 00~3F.
- (8) Data Setting
It can be set when trigger condition is “Data” or “ID and data”, it can set length of byte and data.
 - a. Length of byte: set the byte number of data to be triggered, which can set to 1~8.
 - b. Data: set the data to be triggered, which can set to 00~FFFFFFFFFFFFFFFF.

(9) Error Setting

It can be set when trigger condition is “error”, it can set synchronization, ID parity check and checksum.

- a. Synchronization: synchronizing error
- b. ID parity check: ID parity check error
- c. Checksum: data check and error

(10) Setup Data Length

Set whether display the setting menu of the data length, it can set yes or no. when “yes” is selected, the data length menu will be displayed, select “no”, the data length menu will not display.

(11) Data Length

Set the data length of LIN, which can set to 1~8, it is valid only setup data length is “yes”.

7.19 DECODE

DECODE button can set protocol decoding bus, such as bus status, display format, event list and position.

- a. Bus Status: set decoding bus to on or off
- b. Display Format: set the display format of decoding format, which can set to hexadecimal, decimal, binary and ASCII.
- c. Event List: the decoded data on the data line, the corresponding line number, time, data and parity data will display in the format of a table, it's helpful to observe the longer decoded data.
- d. Vertical Position: Change the display position of bus by adjusting Multipurpose knob, which can set to -160 ~ 160.
- e. Trigger Setting: it can jump to trigger menu

Note: For I²C trigger, if there are signs READ and WRITE in the bus decoded data, the abbreviated R and W are used in the bus instead.

8. Automatic Measurement

- 8.1 Parameter Measurement
- 8.2 Automatic Measurement Menu
- 8.3 All Parameters Measurement
- 8.4 User Defined Parameters

Automatic measurement contains all parameter automatic measurement, user-defined parameter measurement, user-defined parameter measurement statistic, digital voltage meter, indicator and selection indicator.

8.1 Parameter Measurement

UPO1000CS series oscilloscope can automatically measure 36 kinds of parameters. It includes voltage, time and other.

① Voltage

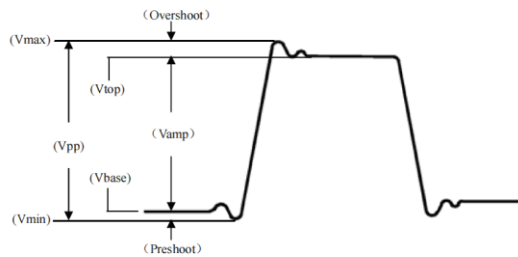

Max: The voltage from the highest point of the waveform to GND.

Min: The voltage from the lowest point of the waveform to GND.

High: The voltage value from the flat top to GND.

Low: The voltage value from the bottom to GND.

Middle: Half of the sum of the voltage values at the top and bottom of the waveform

Pk-Pk: Peak-to-peak value, the voltage value from the highest point to the lowest point of the waveform.

Amp: Voltage from top to bottom of the waveform.

Mean: The average amplitude of the waveform in the screen.

CycMean: Average amplitude of the waveform in one period.

RMS: The effective value. The energy generated by the conversion of AC signal, it corresponds to the DC voltage that generates equivalent energy.

CycRMS: The energy produced by the conversion of AC signal in a period, it corresponds to a DC voltage that generates equivalent energy.

AC RMS: The RMS value is the waveform which DC component has removed.

② Time

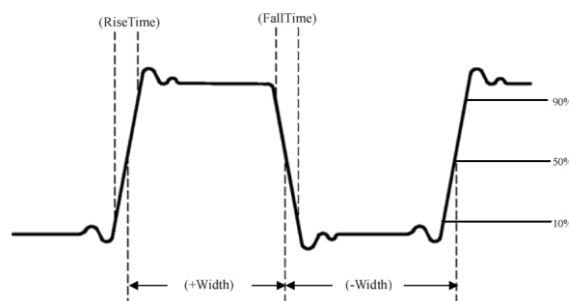

Period: Time between two consecutive, same-polarity edges of a repetitive waveform.

Frequency: The reciprocal of the period.

Rise time: Time needed for waveform amplitude rising from 10% to 90%.

Fall time: Time needed for waveform amplitude falling from 90% to 10%.

Rise delay: The delay time between the two rising edges of the primary and secondary signals.

Fall delay: The delay time between the two falling edges of the primary and secondary signals.

+Width: The width of a positive pulse at 50% amplitude.

-Width: The width of a negative pulse at 50% amplitude.

FRFR: Time from the first rising edge of source 1 to the first rising edge of source 2

FRFF: Time from the first rising edge of source 1 to the first falling edge of source 2

FFFR: Time from the first falling edge of source 1 to the first rising edge of source 2

FFFF: Time from the first falling edge of source 1 to the first falling edge of source 2

FRLF: Time from the first rising edge of source 1 to the last falling edge of source 2

FRLR: Time from the first rising edge of source 1 to the last rising edge of source 2

FFLR: Time from the last falling edge of source 1 to the last rising edge of source 2

FFLF: Time from the last falling edge of source 1 to the last falling edge of source 2

③ Others

+Duty: Ratio of positive pulse width to period.

-Duty: Ratio of negative pulse width to period.

OverSht: The ratio of the difference between the maximum value and the top value of a waveform to its amplitude.

PreSht: The ratio of the difference between the minimum value and the bottom value of a waveform to its amplitude.

Area: The algebraic sum of the time product of voltage at all points on the screen.

CycArea: The algebraic sum of the time product of voltage at all points in a cycle of waveform.

Phase: The phase difference between the master source and the slave source.

Pulse Count: Completed rising edge number on the screen.

8.2 Automatic Measurement Menu

Press **MEASURE** button on the front panel to enter the automatic measurement menu.

Automatic Measurement Menu

Functions	Options	Descriptions
Main Source	CH1,CH2,MATH	Select any of CH1, CH2, MATH for automatic parameter measurement
Slave Source	CH1,CH2,MATH	Select the second source that requires two channels for measurement

All Parameter	OFF	Turn off display frame of all parameter measurement
	ON	Pops up a display frame of all parameters on the waveform display area
User-defined		<p>A user-defined parameter selection interface pops up on the waveform display area, adjust the Multipurpose knob to select and press the knob to confirm to show the parameter on the screen.</p> <p>Press the user defined key again to close the user-defined parameter choice box.</p>
Measurement Statistical Analysis	OFF	Turn off measurement statistical function
	Extremum	<p>Automatic calculates and displays the current user defined parameters, the average, maximum, and minimum.</p> <p>Only enabled when user defined parameters display on the screen.</p>
	Difference	<p>Automatic calculates and displays the current user defined parameters, the average, standard deviation and measurement times.</p> <p>Only enabled when user defined parameters display on the screen.</p>
Digital Voltage Meter	Digital Voltage Meter	Turn on/off the measurement of digital voltage meter, the current measured value will display on the top of the screen.
	Source	Measuring source can set to CH1,CH2.
	Mode	It can set to DC, DC RMS and AC RMS
Selection Indicator		Press <u>Multipurpose</u> knob to select the parameter of selection indicator.
Indicator	Off	Turn off the indicator function
	On	Indicate the physical significance of the indicator parameter intuitively by line
Delete		Clear all the user-defined parameter

8.3 All Parameters Measurement

Press **MEASURE** to pop out all parameter to measuring all parameters, as shown in Figure 8-1.

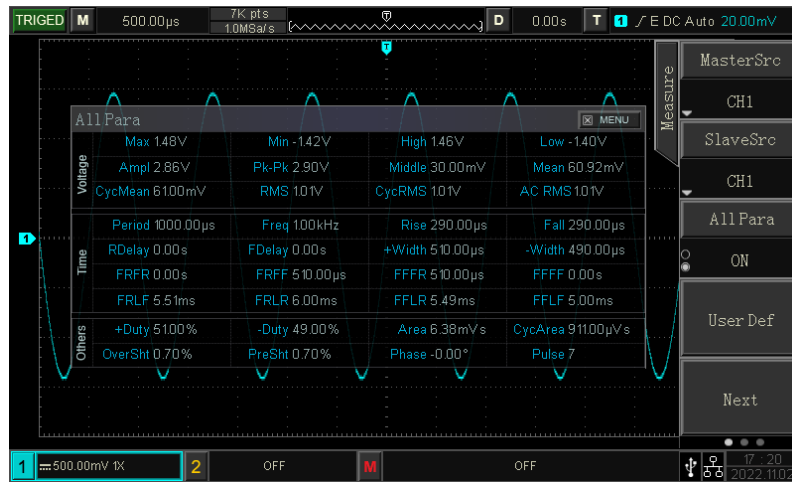

Figure 8-1

All parameters are always marked the same color with the current measuring channel (the main source). When "----" is shown, it indicates that the current source has no signal input, or the measurement result is not valid range (too large or too small).

8.4 User Defined Parameters

Press **MEASURE** to pop out user defined, as shown in Figure 8-2.

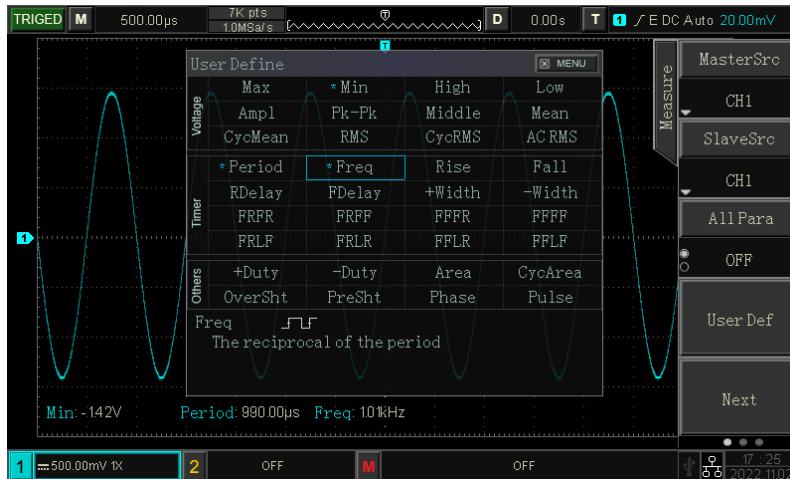

Figure 8-2

Rotating the Multipurpose knob to select parameter and press the knob to confirm. For every selected parameter, a * symbol will appear in front of the parameter. The user defined parameter will display on the bottom of the screen, it can measuring 5 parameters at the same time.

User can select difference value, extremum to measuring statistic the user-defined parameters.

9. Cursor Measurement

9.1 Time Measurement

9.2 Voltage Measurement

The cursor can be used to measure the X axis value (time) and the Y axis value (voltage) of the selected waveform.

Press the **CURSOR** button to enter the cursor measurement menu.

9.1 Time Measurement

Press the **CURSOR** button to enter the cursor measurement menu, select enable, type, source, mode, transparenance to measuring time, as shown in Figure 9-1.

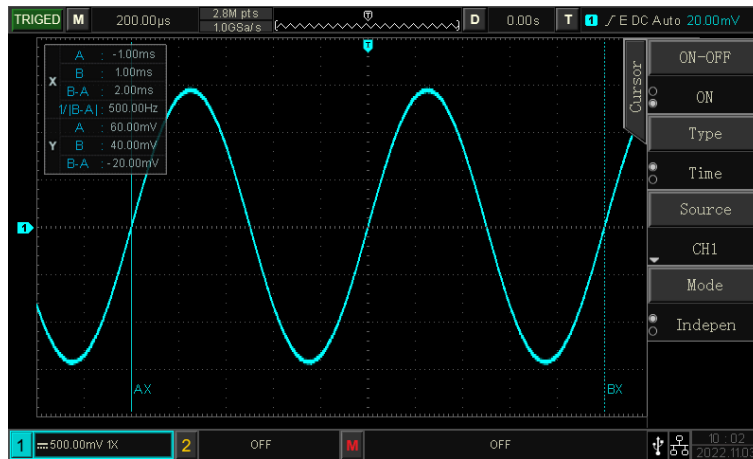

Figure 9-1

The upper left corner of the display area shows the cursor measurement information: “X” indicates the time measurement, and “Y” indicates the voltage measurement. Press **Multipurpose** knob to adjusting the horizontal position of A, B to achieve time measurement.

9.2 Voltage Measurement

Voltage measurement is the same as time measurement, the difference is the vertical cursor of time measurement change to horizontal cursor.

Press the **CURSOR** button to enter the cursor measurement menu, select voltage, source, mode, transparenance to measuring voltage, as shown in Figure 9-2

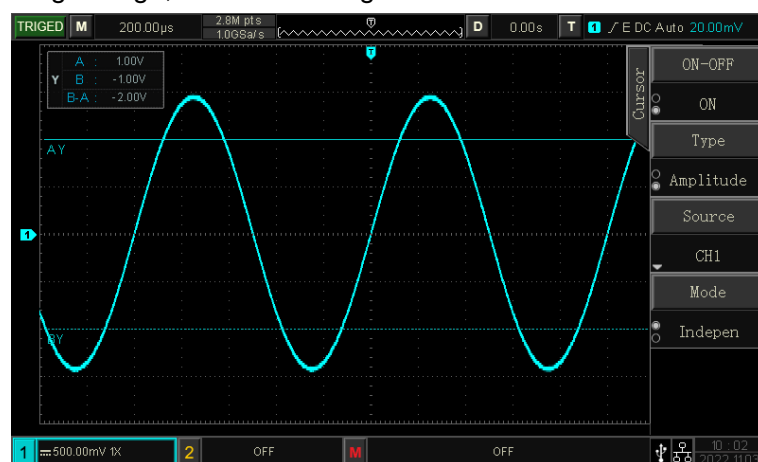

Figure 9-2

The upper left corner of the display area shows the cursor measurement information: Y presents the result of voltage measurement, Press **Multipurpose** knob to adjusting the vertical position of A, B to achieve the voltage measurement.

10. Sampling System

10.1 Sampling Rate

10.2 Acquisition Mode

10.3 Storage Depth

Sampling is taking analog input and converts into a discrete points using analog to digital converter (ADC).

10.1 Sampling Rate

(1) Sampling and Sampling Rate

Sampling is the oscilloscope sample the input analog signal and then convert it to digital data. Gathering the digital data to waveform record and stored in memory.

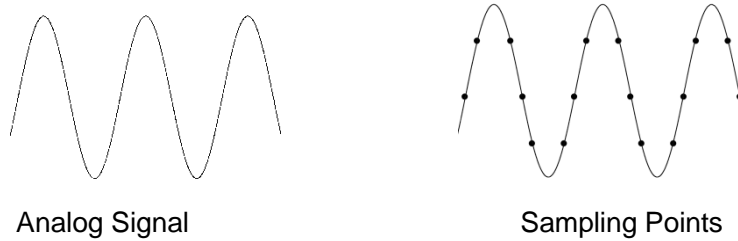

Sampling rate refers to the time interval between two sampling points. The maximum sampling rate of the UPO1000CS series is 1 GS/s.

The sampling rate will be affected by the timing scale and the change of storage depth. UPO1000CS oscilloscopes sampling rate is displayed in real-time at the top of the screen in the status bar. The horizontal SCALE knob can adjust the horizontal time base or modify the memory depth to change it.

(2) The influence of low sampling rate

- ① **Waveform Distortion:** Due to low sampling rate, the details of the waveform might be missing, the sampling waveform might be different than the actual signal.

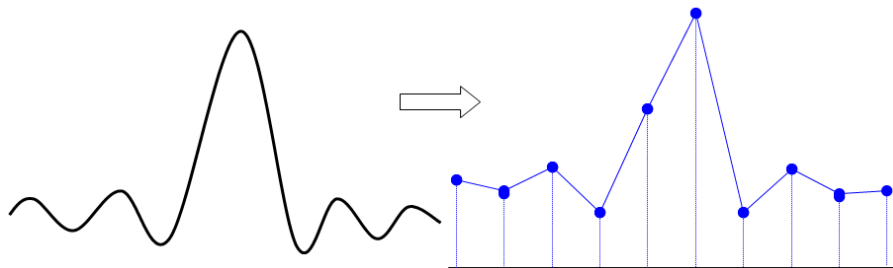

- ② **Wave Mixing:** When the sampling rate is 2 times lower than the actual signal frequency (Nyquist frequency), the frequency of the reconstructed signal will be less than the actual signal frequency.

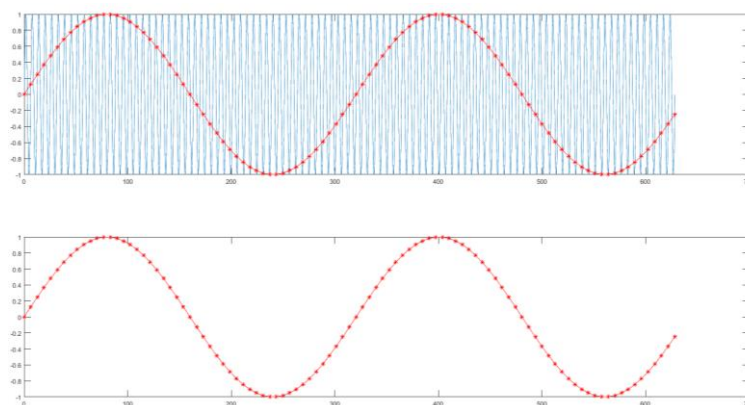

- ③ **Waveform Leakage:** Due to low sampling rate, the reconstructed waveform might not reflect the

actual signal.

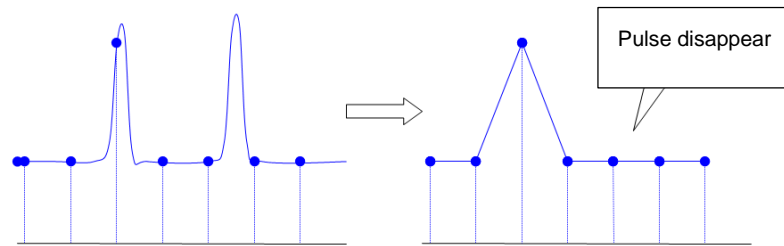

10.2 Acquisition Mode

To obtain a waveform from sampling points, press the **ACQUIRE** → sampling mode to select acquisition mode.

(1) Normal Sampling

The signal is sampled and reconstructed with equal time intervals. For most waveforms, this mode can perform the best display.

(2) Peak Sampling

The maximum and minimum values of the input signal are found at each sampling interval, and the waveform is displayed these values. The oscilloscope can acquire and display a narrow pulse, otherwise the narrow pulse might be missed in the normal mode. Noise might be enlarged in this mode.

(3) High Resolution

The oscilloscope will averages the adjacent points of the sampled waveform and reduce random noise from the input signal and generate smoother waveforms.

(4) Average

The oscilloscope obtains several waveforms to take the average, and display the final waveform. This method can reduce random noise.

By changing the acquisition mode setting to observe the waveform changes. If the signal contains large noise, when the average mode is not adopted and when the 32 times average mode is adopted, the sampled waveform is shown in the following figure.

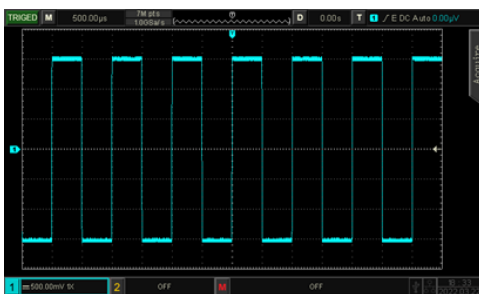

Waveform when the average mode is not adopted

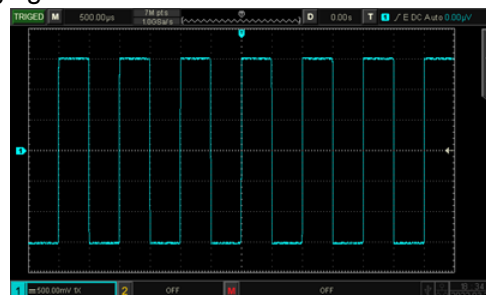

waveform when the 32 times average mode

Note: Average and high resolution uses different average methods. The former is multiple sampling average, the latter is single sampling.

10.3 Storage Depth

The storage depth is the number of waveforms that can be stored in the oscilloscope during a trigger acquisition. It reflects the memory storage capacity of the acquisition.

The relation of storage depth, sampling rate and waveform length should meet the pattern:

storage depth = sampling rate \times horizontal time base \times the number of grid of horizontal direction

UPO1000CS the maximum storage depth 56 Mpts (per channel).

In **ACQUIRE** menu, user can freely to set the storage depth to auto, 7k, 70k, 700k, 7M, 35M, 56M. The default setting is auto.

11. Display System

11.1 Waveform Display Setting

DISPLAY can set the display type of waveform, XY, grid brightness, waveform brightness, duration time, color temperature, anti-color temperature.

(1) Display Type

- ① Vector: This mode provides the most realistic waveform in most cases and makes it easy to view the steep edges of the waveform (e.g. square wave).
- ② Point: Displays sampling points directly.

(2) Grid

Grid type can be set in the DISPLAY menu, which includes full display, grid, crosshair and frame.

(3) Grid Brightness

Rotating multipurpose knob to set the grid brightness, the default value is 40%.

(4) Waveform Brightness

Rotating multipurpose knob to set the waveform brightness, the default value is 50%.

(5) Backlight Brightness

It can set the screen backlight brightness, rotating multipurpose knob to set the brightness, the default value is 50%.

(6) Duration Time

Duration time of waveform can be set to the minimum value, 50ms, 100ms, 200ms, 500ms, 1s, 5s, 10s, 20s, infinite afterglow, the default value is the minimum.

(7) Color Temperature

It can intuitively reflect the probability of the occurrence of waveform signals. The waveform with high frequency is displayed in warm color, and the waveform with low frequency is displayed in cold color.

(8) Anti-color Temperature

Anti-color temperature is the opposite of color temperature function, it takes effects when the color temperature function is enabled.

(9) Menu Display

Set the time of menu display, which can set to 5s, 10s, 20s and manual.

(10) Transparence

Turn on transparence in display menu, set the pop-up frame whether is transparence, it can set to on or off.

12. Storage and Callback

- 12.1 Storage and Load Setting
- 12.2 Waveform Storage and Load
- 12.3 Picture Storage
- 12.4 Print Screen
- 12.5 Saved Path

With the storage function, user can save the oscilloscope's settings, waveforms, and screen images to the oscilloscope or external USB storage devices, and load the saved settings or waveforms anytime. Press the **STORAGE** key to enter the storage function setting interface.

Note: For the external USB storage device, only supports FAT32 format, the NTFS format is not compatible.

12.1 Storage and Load Setting

Table 12-1 Storage Menu Setting

Functions	Option	Descriptions
Type	Setting	
Disk	Local	Press save, the setting will be saved in the oscilloscope
	USB	Press save, the setting will be saved in external USB storage device
Filename		Press filename to pop out the virtual keyboard, adjusting Multipurpose knob to select letter and numeric, the length limit is 12 characters.
Save		Performing the save setting, save the setting to the specified storage location.
Load		Loading the previously saved settings in the specified memory location, return the oscilloscope to the previously saved setting state.

12.2 Waveform Storage and Load

Table 12-2 Waveform Storage Menu

Functions	Option	Descriptions
Type	Waveform	
Source	CH1, CH2	Set which channel waveform to be saved.
Disk	Lock	Press save, the waveform will be saved in oscilloscope
	USB	Press save, the waveform will be saved in external USB storage device
	USB CSV	Press save, the waveform will be saved as .csv format in external USB storage device, this format can use Excel software open on PC
Filename		Press filename to pop out the virtual keyboard, adjusting Multipurpose knob to select letter and numeric, the length limit is 12 characters.
Save		Performing the save setting, save the setting to the specified storage location.

After the waveform is saved, user can select the REF key to load waveform.

Table 12-3 REF Waveform Load Menu

Functions	Option	Descriptions
Reference	Ref-A、 Ref-B	Select any of the two references to load waveforms
Disk	Local	Press REF, loading the waveform form internal of the oscilloscope
	USB	Press REF, loading the waveform from external USB storage device
Load		Press REF to pop out the select file frame, adjusting Multipurpose to select file
Delete		Turn off the current REF waveform

The callback REF waveform is shown in Figure 12-1.

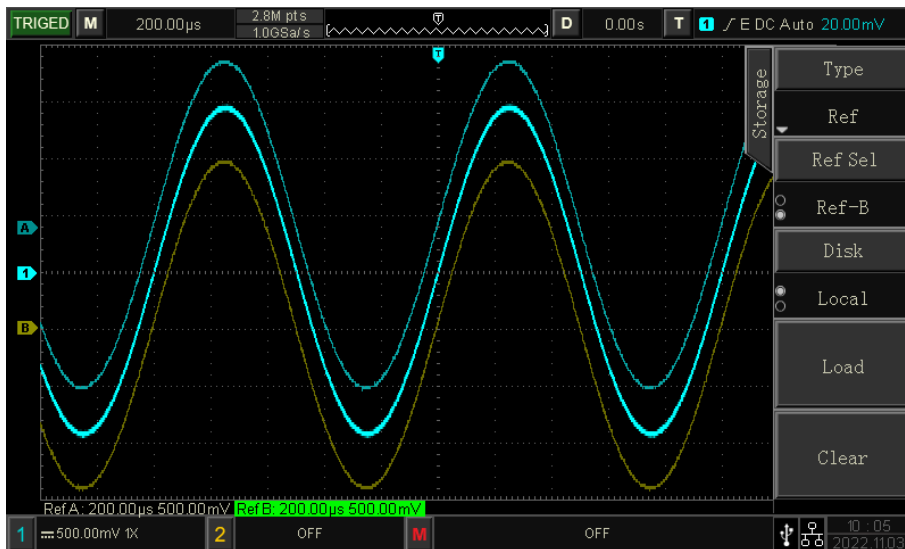

Figure 12-1

After the callback, the Ref waveform status will be displayed in the lower left corner, including time base scale and amplitude scale. User can use the vertical and horizontal control knob to adjust the Ref waveform position on the screen and the time base scale and the amplitude scale.

Remark

- Only when the oscilloscope is connected to an external USB storage device, user can select the disk as USB, and then save the settings to the USB storage device. When the USB storage device is not connected, it will prompt “Detect USB device is failed.”

12.3 Picture Storage

Table 12-4 Picture storage

Function	Setting	Description
Type	Picture	
Format	Original picture	Oscilloscope screenshot is saved in the color displayed on the oscilloscope interface
	Save ink	Oscilloscope screenshot will turn the dark background into light color for storage, the purpose is saving ink to printing photos.
	Grayscale	Oscilloscope screenshot will turn the color picture to grayscale picture for storage.
	Save ink & grayscale	Oscilloscope screenshot will turn the dark background into light color, color picture to grayscale picture for storage.
Preview Picture	On	Enter preview, turn on the saved picture in USB and display it on the screen.
	Off	Exit preview
The last		Switch to the last picture in USB
The next		Switch to the next picture in USB

12.4 Print Screen

The **PrtSc** key can be used to store the current screen in BMP format to an external USB storage device. The bitmap can be opened directly on the PC. This function can only be used when external USB storage device is connected.

12.5 Saved Path

After a file or picture is saved on a USB storage device, a UNIT folder is automatically generated in the root directory of the USB storage device. In this folder, lower-level folders are automatically generated based on file types. The saved files are stored in these folders. The system automatically classifies files based on their types and saves them to folders of their own types.

13. Auxiliary Function Setting

13.1 System Function Setting

13.2 Recording Waveform

13.3 Pass/Fail Test

13.4 Web Access

Press the **UTILITY** key to enter the auxiliary function settings menu.

13.1 System Function Setting

(1) Automatic Calibration

Automatic calibration allows the oscilloscope to work optimally to obtain the most accurate measurements. This function can perform at any time, especially when the ambient temperature range reaches or exceeds 5°C. Before performing the automatic calibration operation, make sure that the oscilloscope is operating for more than 20 minutes.

(2) System Information

System Information can view the system information of the oscilloscope, which includes manufacturer, model number, SN code, software version number, logical version number, hardware version number, website, website user name & password and date.

(3) Language

Language can set system language, English, simplified Chinese. By default, language display is the current setting.

(4) Square Waveform Output

Square Output can set the output frequency of local square wave: 10Hz, 100Hz, 1kHz, 10kHz. 1kHz by default.

(5) Frequency Meter

Frequency Meter can set the state of frequency meter (on/off), when the frequency meter is enabled, the frequency information will displayed on the top of screen. Frequency meter is the counter of trigger event frequency in the trigger channel, display as hardware 7 digitals frequency meter.

(6) Output Selection

Output Selection can select output signal by AUX OUT port, it can select “trigger” or “pass/fail”.

Trigger: AUX OUT port outputs the trigger synchronization signal.

Pass/Fail: AUX OUT port outputs the pass/fail signal.

The default selection is “trigger”.

(7) Delete Data

Delete Data can clear the stored waveform setting file, and etc.

(8) Internet Setting

When the device is connected with available internet, IP setting can set the IP, subnet mask and gateway of the oscilloscope.

a. Mode: manual or auto

Manual: it can set IP address and subnet mask by manual

Auto: Only can view the IP address and submask

- b. IP Address: IP address format is nnn.nnn.nnn.nnn, the first nnn range is from 1 to 233, the second nnn range is from 0 to 255. It is recommended that user can consult network administrator for an available subnet mask.
- c. Submask Setting: the format is nnn.nnn.nnn.nnn, the nnn range is from 1 to 255. It is recommended that user can consult network administrator for an available subnet mask.

(9) Time Setting

Time Setting can set the time, year, month, date, hour, minute independently by adjusting the knob to switch the setting. After the setting, the oscilloscope will display the setting time.

(10) Boot Loading

Boot Loading can set whether to automatically set the settings before the shutdown when the oscilloscope starts up. It can set the last setting or the default setting.

Last setting: Load all the settings before shutdown;

Default setting: restore the oscilloscope to the default factory setting after starting up.

13.2 Recording Waveform

Recording Waveform can set to record the waveform, this function includes recording setting, record, stop and display.

(1) Recording Setting

Set the parameter of recording waveform, which includes recording interval, end of frame, playback delay and the maximum frame

- a. Recording Interval: Set the interval between each frame of the waveform recording.
- b. End of Frame: The waveform recording will automatically stop recording when it reaches the end frame.
- c. Playback Delay: Set the interval time between each frame during the waveform playback.
- d. Maximum Frame: Displays the maximum number of frames that can be recorded in the current situation, it cannot be modified (The maximum number of frames will be changed by memory depth).

(2) Record

Star to recording.

(3) Stop

Stop the recording.

(4) Playback

Playback the waveform, press the knob can stop playback. Adjusting the Multipurpose knob to skip to the specified frame.

(5) Quick Recording

It can continuous to record for improving capture waveform rate; waveform will not display on the screen when perform quick recording; it can be played only the record is finished. It can set to on or off.

13.3 Pass/Fail Test

Pass/Fail can set the template and judgment condition to perform Pass/Fail test, which can set allow to test, output, information source, operating, template and stop setting.

The Pass/Fail uses a template to detect whether the input signal within the range of the template requirements. If the input signal exceeds the limited range of the template, it is judged as failed.

(1) Allow to test

Allow to test is to select whether perform test or not. On: turn on to set and perform the test; off: turn off is not allow to perform the test.

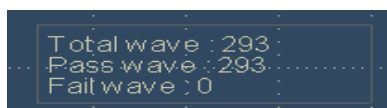

Total Wfs presents the total frame number that has tested

Pass Wfs presents the frame number that has passed

Fail Wfs presents the frame number that has failed

(2) Output

Set which signal output by AUX port, which can set to pass or fail.

- a. Fail: Set the AUX port on the back panel of the oscilloscope to output pulse when “fail” and produce beeps.
- b. Pass: Set the AUX port on the back panel of the oscilloscope to output pulses when “pass” and produce beeps.

Note: AUX output selection needs to be switched to Pass test.

(3) Information Source

Information source is the source pass through the test, which can set to CH1, CH2.

(4) Operating Test

After the testing template, stop setting, source setting are completed, then to set “operating”. On: performing the pass test. Off: turn off the pass test.

(5) Stop Setting

Stop setting is to set the stop conditions for pass/fail test, and automatically stop the test when the conditions are met.

Table 14-1 Condition Setting

Function	Option	Description
Stop Type	Pass Count	Set the Pass/Fail function to stop the test automatically after it reaches the specified threshold count of pass
	Fail Count	Set the Pass/Fail function to stop the test automatically after it reaches the specified threshold count of failure
Condition	>=, <=	Set the stop condition
Threshold		Adjusting Multipurpose knob to set the threshold of stop condition

(6) Template Setting

Template setting is to set the template of pass/fail test. CH1 is used as the reference waveform to create a template by default. If the waveform is within the template range, then the output is successful. If the waveform exceeds the template range, then the output is failed.

Table 14-2 Template Setting

Function	Option	Description
Reference Waveform	CH1, CH2	Specify a channel waveform in CH1~CH2 and plus the horizontal and vertical tolerance as the conditions for creating a template
Horizontal	1~100	Adjusting Multipurpose knob to select the range of horizontal tolerance, the default value is 5
Vertical	1~100	Adjusting Multipurpose knob to select the range of vertical tolerance, the default value is 5

13.4 Web Access

(1) Access Local Area Network

The computer and the oscilloscope are under the same LAN. Check the IP address through the UTILITY menu of the oscilloscope, and then the browser accesses the oscilloscope by IP: 9000 port.

Example:

Computer IP: 192.168.42.3

Oscilloscope IP: 192.168.42.12

PC browser using 192.168.42.12:9000 to access the oscilloscope

View the basic information, as shown in Figure 13-1.

UNI-T	
Homepage Instrument Control Lan Config Password Set Download	
Basic Information	
Manufacturer	UNI-T Technologies
Model	UPO6202Z
Serial Number	c4f31266798
Firmware Version	1.02.36
Lan Information	
IP Address	192.168.20.166
Mask	255.255.255.0
Gateway	0.0.0.0
MAC	ee-3b-d7-3a-36-15
Notice	
Browser Require	The browser needs to support websocket. It is recommended to use chrome V102.0.5005.115 and above
Bandwidth Require	≥100Mbps
Max Connection Count	1
Display Device Require	1080p LCD recommended

Figure 13-1

Log in to check the instrument setting, internet setting and password setting. Web user name and password see Utility/System Information. View waveform and control, as shown in Figure 13-2.

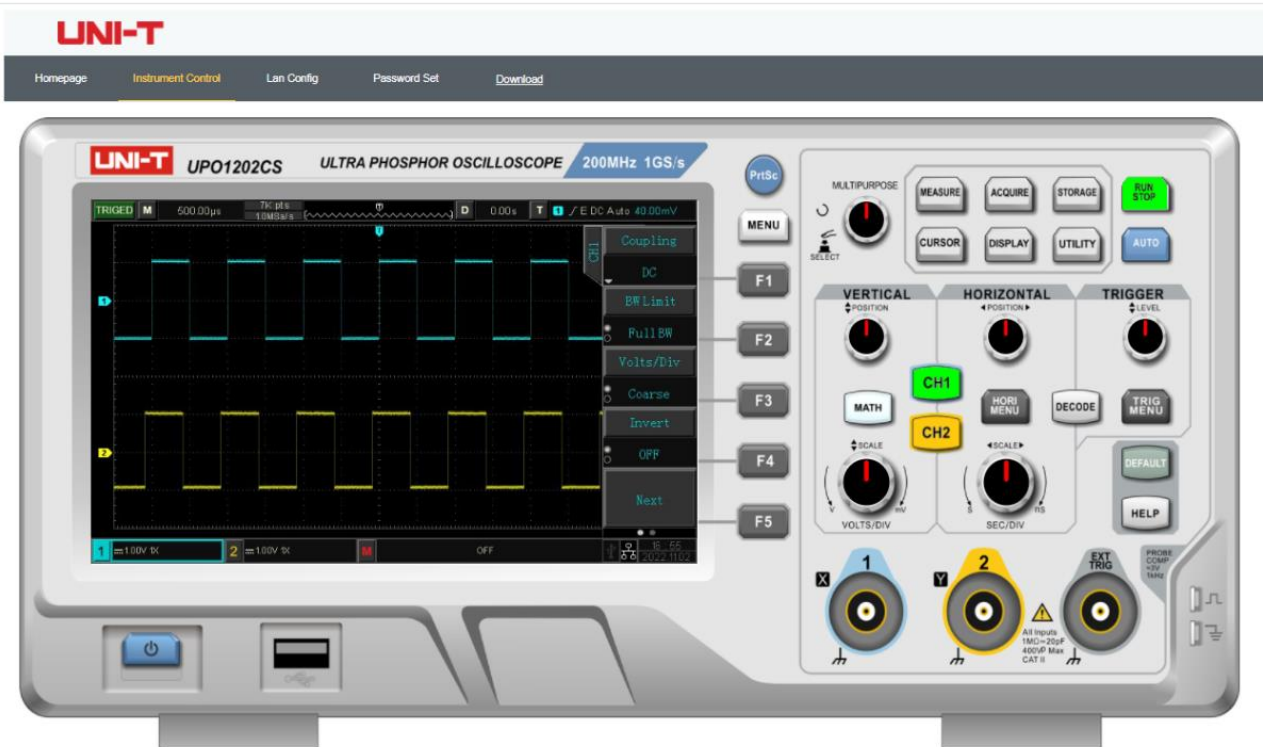

Figure 13-2

In Web page, click the corresponding key and knob to control the oscilloscope. In screen part of the oscilloscope can be set multiple operating, such as

- a. drag waveform cursor to adjust the vertical position of the waveform; drag the trigger position cursor to adjust the trigger position.
- b. click the channel to switch turn on/off the current channel
- c. user mouse wheel to adjust the amplitude volts/div in the channel
- d. user mouse wheel to adjust the timebase scale in timebase position (M)
- e. click left/right slid in the blank to adjust the preset trigger position; click the trigger delay to move the preset position to the center of the screen.
- f. click menu to adjust the setting option directly

The internet setting information of the oscilloscope, as shown in Figure 13-3.

The screenshot shows the 'Lan Config' page of an oscilloscope. At the top, there is a navigation bar with 'Homepage', 'Instrument Control', 'Lan Config' (highlighted), 'Password Set', and 'Download'. Below the navigation bar, the 'Lan Information' section has a 'Type' dropdown menu set to 'DHCP'. A table below it lists 'Item' and 'Value' for IP (192.168.20.166), Mask (255.255.255.0), and Gateway (0.0.0.0). Below the table are 'Modify Lan Config' and 'Confirm' buttons. The 'frp Proxy Information' section has a table with 'Item' and 'Value' for frp IP (121.37.220.55), web port (9000), pic port (9002), and ctrl port (9001). Below this table are 'Modify frp Proxy', 'Query frp used port', and 'Confirm' buttons.

Figure 13-3

(2) Access Outer Network

- a. Plug the network cable into the oscilloscope and the network can be access internet
- b. Open frp proxy service on the server
- c. Configure the oscilloscope frp proxy IP and port
- d. The browser can access the proxy IP:9000 port, and the access interface LAN is consistent.

Note:

This oscilloscope uses frp intranet penetration way to achieve external network access. frp use version is 0.34.0. This machine with frp-0.34.0 client, it need use with the server, the server needs to open frp server, the client connects to the frp server port is 7000, so the server needs to configure bind_port = 7000

(3) Network Parameter Setting

a. Local area network setting

It should log in to access the internet setting of the oscilloscope, web user name and password see see Utility/System Information. The setting interface as shown in Figure 13-4.

The screenshot shows a web interface with a navigation bar at the top containing 'Homepage', 'Instrument Control', 'Lan Config' (highlighted), 'Password Set', and 'Download'. Below the navigation bar, there are two main sections: 'Lan Information' and 'frp Proxy Information'.
Lan Information: A dropdown menu for 'Type' is set to 'DHCP'. Below it is a table with columns 'Item' and 'Value'. The rows are: IP (192.168.20.166), Mask (255.255.255.0), and Gateway (0.0.0.0). Below the table are two buttons: 'Modify Lan Config' and 'Confirm'.
frp Proxy Information: A table with columns 'Item' and 'Value'. The rows are: frp IP (121.37.220.55), web port (9000), pic port (9002), and ctrl port (9001). Below the table are three buttons: 'Modify frp Proxy', 'Query frp used port', and 'Confirm'.

Figure 13-4

Internet information setting includes IP address acquisition method (dhcp/static), local IP address, subnet mask and gateway. If IP setting is dhcp, it not need to fill in the configuration IP address, subnet mask and gateway, click confirmation directly. If IP setting is STATIC, it should fill in the correct IP address, subnet mask and gateway, and then click confirmation, as shown in Figure 13-5.

The screenshot shows the 'Lan Information' configuration form. At the top, the title 'Lan Information' is displayed. Below it, the 'Type' dropdown menu is set to 'DHCP'. A table with columns 'Item' and 'Value' contains the following data: IP (192.168.20.166), Mask (255.255.255.0), and Gateway (0.0.0.0). Below the table, there are two buttons: 'Modify Lan Config' and 'Confirm'.

Figure 13-5

Click the confirmation after the input is completed, it can continuous to access according to the new modified IP address information (in correct configuration)

b. frp proxy network information setting

The setting interface setting as shown in Figure 13-6.

Lan Information

Type
DHCP

Item	Value
IP	192.168.20.166
Mask	255.255.255.0
Gateway	0.0.0.0

Modify Lan Config Confirm

frp Proxy Information

Item	Value
frp IP	121.37.220.55
web port	9000
pic port	9002
ctrl port	9001

Modify frp Proxy Query frp used port Confirm

Figure 13-6

frp proxy network information setting includes frp proxy network server IP address, web_port, pic_port proxy port, ctrl_port proxy port.

Click to change frp setting, that is to edit proxy IP address, web_port, pic_port, ctrl_port, as shown in Figure 13-7.

frp Proxy Information

Item	Value ?
frp IP	121.37.220.55
web port	9000
pic port	9002
ctrl port	9001

Modify frp Proxy

Query frp used port

Confirm

Figure 13-7

Click the confirmation after the input is completed, it can continuous to access according to the new modified frp proxy IP address information (in correct configuration)

Note:

If each oscilloscope is connect with the same frp server, then web_port, pic_port, ctrl_port of each oscilloscope should be consistent , otherwise frp proxy fails and cannot access.

If frp proxy is modified, it cannot access by local area network IP: 9000. If user need to recover the normal access, press the DEFAULT button on the oscilloscope panel to reset the configuration and then use IP: 9000 port to access.

(4) Password Setting

Password setting is for the user account to log in. After the user changes the login password, the user needs to use the new password for the next login. If you forget the password, reset the password by pressing the DEFAULT button on the oscilloscope panel.

14. Mathematical Operation

14.1 Mathematical Function

14.2 FFT

14.3 Logical Operation

14.4 Digital Filter

14.5 Advanced Operation

UPO1000CS series digital phosphor oscilloscope carries a variety of mathematical operations, it includes math, FFT, logical operation, digital filter and advanced operation.

Enter mathematical operation menu, adjusting POSITION or SCALE knob on vertical control area to change the vertical position and the vertical scales of the waveforms. The math operation waveforms cannot be independent adjust the horizontal time base scale. it will change automatically according to the horizontal time base scale of the analog input channel.

Math operation cursor  marks the result of a mathematical operation.

14.1 Mathematical Function

Use operator “+”, “-”, “x”, “÷” to operating the channel waveform to get the math waveform.

(1) Operator

Operator supports “+”, “-”, “x”, “÷”.

- a. +: The waveforms of source 1 and source 2 are added point by point.
- b. -: The waveforms of source 1 and source 2 are subtracted point by point.
- c. x: The waveforms of source 1 and source 2 are multiplied point by point.
- d. ÷: The waveforms of source 1 and source 2 are divided point by point.

14.2 FFT

Using FFT (Fast Fourier Transform) mathematical operations, the time domain signal (YT) can be converted into frequency domain signal. The following types of signals can be easily observed by using FFT:

- Harmonic content and distortion in measurement system;
- Perform the noise feature in DC power supply;
- Vibration Analysis;

(1) Vertical Unit

The unit of the FFT operation result can select Vrms and dBVrms. Vrms and dBVrms display the vertical amplitude size in a linear way and decibel volts way. If the FFT spectrum need to display in a large dynamic range, dBVrms is recommended.

(2) Frequency Range

a. Range

- Start Frequency: Set the start sweep frequency of FTT.
- End of Frequency: Set the end sweep frequency of FTT.
- Follow: It can set ON or OFF. ON: start frequency and end of frequency will be linkage. OFF: start frequency and end of frequency will not be linkage.

b. Bandwidth

- Center Frequency: Set the center frequency of the FFT waveform and the FFT waveform will be changed accordingly.
- Frequency Bandwidth: Set the sweep frequency of bandwidth.

(3) FFT Count

Perform a data count of FFT operation, the count larger the resolution is higher, the corresponding refresh speed will be slower. It can set to 8K, 16K, 32K, 128K, 256K, 512K and 1M.

(4) Window

Window function, it can select Hamming, Blackman, Rectangle and Hanning.

- a. Rectangle: It has the best frequency resolution and the worst amplitude resolution, which is similar to the one with no window. It is suitable for measuring the following waveforms:
 - Transient or short pulse, the signal level is almost equal to before and after.
 - Equal amplitude sine wave with very similar frequency.
 - Wide-band random noise in a slowly changing spectrum.
- b. Hanning: Compared with the rectangle window, it has better frequency resolution, but poorer amplitude resolution. It is suitable for measuring sine, periodic and narrow-band random noise waveforms.
- c. Hamming: The frequency resolution is slightly better than that of Hanning window, and it is suitable for measuring transient or short pulse, and the waveform with great difference before and after the signal level.
- d. Blackman: It has the best amplitude resolution, and the worst frequency resolution. It is suitable for measuring the single frequency signals or seeking higher harmonics.

(5) Display Mode

It can set to full screen, split screen and waterfall curve-1, waterfall curve-1.

- a. Split screen: Display the source waveform and the waveform of FFT frequency spectrum waveform in split screen, and extend display the spectrum.
- b. Full screen: Superimposed display the source waveform and the FFT frequency spectrum waveform in full screen. User can observe the spectrum more clearly and make more accurate measurements.
- c. Waterfall curve-1: Waveform, frequency spectrum and waterfall curve are separate display in 3 window. dB value changes with the time in frequency spectrum display on waterfall curve. It has record function.
- d. Waterfall curve-2: frequency spectrum and waterfall curve are separate display in 2 window. It has record function, as shown in Figure 14-1.
 - Segment Selection: In STOP state, use Multipurpose knob to select segment and view the frequency spectrum which corresponding to a point in time on the waterfall curve, it can record up to 200 the frequency spectrum which correspond to waterfall curve.

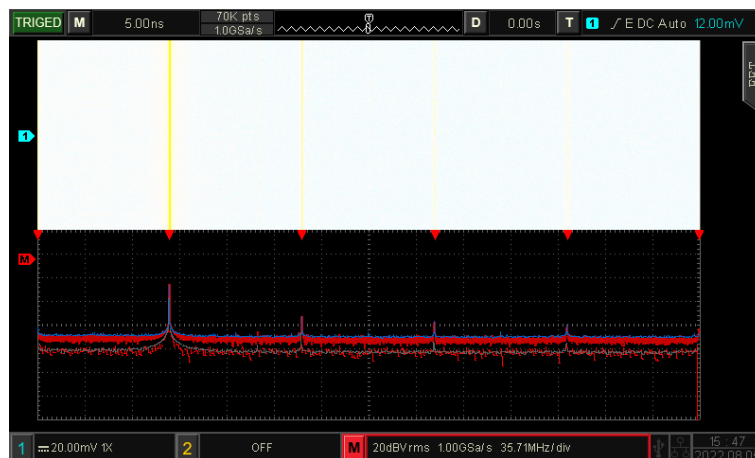

Figure 14-1

(6) Detecting Mode

The detecting mode is to set the way to display the sampling points of the raw data after FFT operation. The display mode can be set to normal, average, maximum hold and minimum hold. The sampling point mode can be set to + peak, - peak, average and interval, as shown in Figure 14-2.

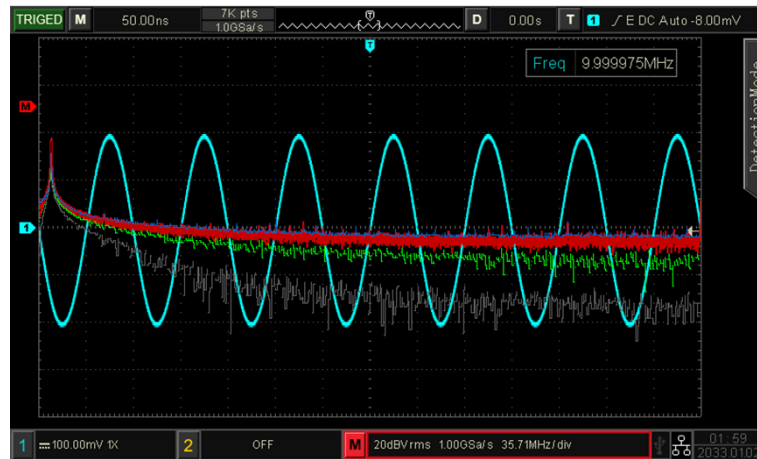

Figure 14-2

Display Mode

- Normal: the spectrum waveform displays all sampled values, the corresponding spectrum waveform is displayed in red color.
- Average: the spectrum waveform displays the average value by sampling point in time interval, the corresponding spectrum waveform is displayed in green color.
Average time: set the number of times of the average calculation, when the average spectrum is enabled, the number of times can be set in the range of 2~512. The larger the number, the smoother the average spectrum.
- Maximum hold: the spectrum waveform displays the maximum value among the multiple sampling data, and the corresponding spectrum waveform is displayed in blue.
- Minimum hold: the spectrum waveform displays the minimum value among the multiple sampling data, and the corresponding spectrum waveform is displayed in gray.

Sampling Point Mode

- OFF: turn off the detection display
- + Peak: take the maximum value within the range of each sampling point.
- Peak: take the minimum value within the range of each sampling point.
- Average: take the average value within the range of each sampling point.
- Interval: perform sampling in the same time interval.

Reset trace: fresh every spectrum data

Note: a detection trace must be displayed in detecting mode

(7) Spectrum Marker

To mark the point in spectrum and display frequency value and voltage value. Mark mode: off, auto, threshold and manual. The default setting is off.

- a. OFF: turn off the marker function
- b. Auto
 - Marker source: Select spectrum wave as the marker source, which is the spectrum waveform generated by different detection types under the detecting mode, it can set to real time, average, maximum hold and minimum hold. Not open trace is gray by default.
 - Marker count: Set the counts to be marked, the range can set to 1~50.
 - Marker list: Display the information of current marker point, including point number, frequency and voltage, which can be set to on or off, default state is off.
- c. Threshold
 - Marker source: Select spectrum wave as the marker source, which is the spectrum waveform generated by different detection types under the detecting mode, it can set to real time, average, maximum hold and minimum hold. Not open trace is gray by default.
 - Threshold: Set the threshold value to be used as a comparison condition, and mark those greater than the threshold value and less than the threshold value will not be marked.
 - Marker list: Display the information of current marker point, including point number, frequency and voltage, which can be set to on or off, default state is off.
- d. Manual: use Multipurpose knob to move marker to arbitrary point.
 - Marker source: Select spectrum wave as the marker source, which is the spectrum waveform generated by different detection types under the detecting mode, it can set to real time, average, maximum hold and minimum hold. Not open trace is gray by default.
 - Marker peak: Mark the peak value of the current directly.

(8) User's Presetting

Change the display mode to full screen by default. Other settings remain unchanged.

FFT Operation Tips

Signals with DC components or deviations can cause errors or deviations in the FFT waveform components.

To reduce the DC component, the channel can be set to AC coupling.

To reduce the random noise and aliasing frequency components of the repetitive or single pulse, user can set the oscilloscope acquisition mode to average acquisition.

14.3 Logical Operation

(1) Expression

- a. AND: Performing "AND" logical operation for every point of source 1 and source 2.
- b. OR: Performing "OR" logical operation for every point of source 1 and source 2.
- c. NOT: Performing "NOT" logical operation for every point of source 1, source 2 will not be displayed at this moment.
- d. XOR: Performing "XOR" logical operation for every point of source 1 and source 2.
Perform logical operations for all points of the source waveform voltage and display the results.

During the operation, when the voltage value of source channel is greater than the threshold value, it is determined as logic “1”, otherwise it is logic “0”. Turn waveform to the binary system and then perform the logical operation. Four types logical operation as shown in Table 14-1.

Table 14-1

Source 1	Source 2	AND	OR	XOR	Source1	NOT
0	0	0	0	0	0	1
0	1	0	1	1	1	0
1	0	0	1	1		
1	1	1	1	0		

(2) Inverse

Inverse can select on or off. ON: Invert the waveform of the logical operation.

(3) Threshold 1

Adjusting the Multipurpose knob to change the value of Threshold 1. When the voltage value of the source channel is greater than the value of Threshold 1, it is identified as logic “1”, otherwise it is logic “0”.

(4) Threshold 2

Adjusting the Multipurpose knob to change the value of Threshold 2. When the voltage value of the source channel is greater than the value of Threshold 2, it is identified as logic “1”, otherwise it is logic “0”.

14.4 Digital Filter

(1) Digital Type

- Low pass: Only signal with the source frequency lower than the current frequency upper limit are allowed to pass.
- High pass: Only signal with the frequency higher than the current frequency lower limit are allowed to pass.
- Band pass: Only signal with the frequency higher than the current frequency lower limit and lower than the current frequency upper limit are allowed to pass.
- Band elimination: Only signal with the frequency lower than the current frequency lower limit or higher than the current frequency upper limit are allowed to pass.

(2) The lower limit of frequency

Adjusting the Multipurpose knob to change the value of the lower limit of frequency. When in low pass, the lower limit of frequency is invalid and the menu is hidden.

(3) The upper limit of frequency

Adjusting the Multipurpose knob to change the value of the high limit of frequency. When in high pass, the high limit of frequency is invalid and the menu is hidden.

Note: The setting range of the upper/lower limit of frequency is related with the current horizontal time base.

14.5 Advanced Operation

User can freely defined the operation of each signal of input channel to get different operation result of MATH waveform.

(1) Expression

It can set on or off, turn on expression to pop out Math-Advance dialog box, as shown in Figure 14-3.

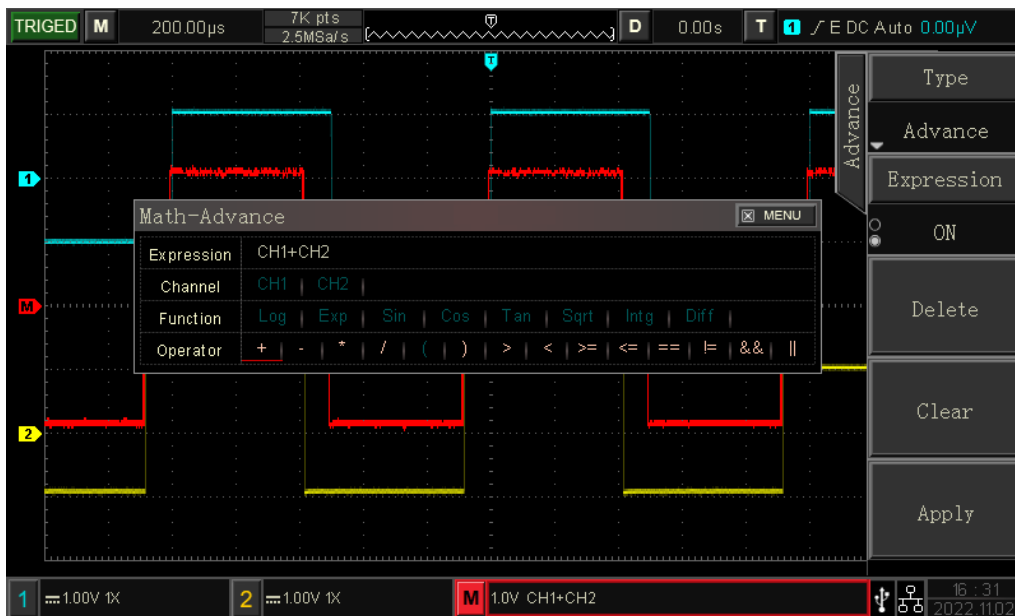

Figure 14-3

Adjust the Multipurpose knob to select "Channel", "Function", or "Operator", then press the knob to display the options in the list after Expression.

When editing the expression, user can press the delete key to "delete", "clear" and "application" the expression. After applying the expression, the oscilloscope performs operations according to the expression and displays the result.

(2) Description of Math-Advance

- Expression: Here refers to the formula consisting of channel, function, variable, and operator. The length of the expression must not exceed 40 characters.
- Channel: channel selection, it can select CH1, CH2.
- Function: Function selection as shown in Table 14-2.

Table 14-2 Advanced Operation Function

Function Name	Description
Log	Calculates the logarithm of the selected logarithm.
Exp	Calculates the index of the selected source
Sin	Calculates the sine value of the selected source.
Cos	Calculates the cosine value of the selected source.
Tan	Calculates the tangent value of the selected source.
Sqrt	Calculates the square root of the selected source.
Intg	Calculates the integral of the selected source.
Diff	Calculates the discrete-time differential of the selected source.

d. Operator: The function of each operator as shown in Table 14-3.

Table 14-3

Function Name	Description
+, -, x, ÷, ^	Arithmetic operators: add, subtract, multiply, divide, index
()	Parenthesis, it is used to increase the operation priority within parenthesis
<, >, >=, <=, ==, !=	Relational operators: less than, greater than, less than or equal to, greater than or equal to, equal, not equal to.
, &&	Logical operators: or, and

15. Additional Function Key

15.1 Auto Setting

15.2 Run/Stop

15.3 Factory Setting

15.1 Auto Setting

Automatic settings will choose appropriate time base scale, amplitude scale and trigger parameter according to the input signal so that the waveform will automatically display on the screen. Press the **AUTO** key to enable automatic settings.

Automatic setting only applies to the following conditions:

- Automatic setting is only suitable for simple single frequency signal. It is impossible to achieve effective automatic setting for complex combination waves.
- The measured signal frequency is not less than 20 Hz, and the amplitude is not less than 20 mVpp; the duty cycle of square wave is greater than 5%.

15.2 Run/Stop

Use the **RUN/STOP** key on the front panel to set. When the key is pressed and the green light is on, it indicates the RUN state, and if the red light is on after the key press, it is the STOP state.

In the running state, the oscilloscope is continuously acquiring waveform and the upper part of the screen shows "AUTO"; in the stop state, the oscilloscope stops the acquisition and the upper part of the screen shows "STOP". Press the **RUN/STOP** key to switch the waveform sampling between the run and stop states.

15.3 Factory Setting

Press the **DEFAULT** key on the front panel, the oscilloscope can quickly restore to factory setting. UPO1000CS series digital phosphor oscilloscope factory settings are as shown in Figure 15-1.

Table 15-1

System	Function	Factory Setting
Vertical System	CH1	1V/DIV
	Vertical displacement	0(vertical midpoint)
	Coupling	DC
	Bandwidth limitation	OFF
	VOLTS/DIV	Coarse tuning
	Probe	1x
	Inverse	OFF
	CH2	OFF
	MATH, REF	OFF

Horizontal System	Extension window	OFF
	Multi-Scopes	OFF
	Horizontal time base	1 μ s/div
	Horizontal displacement	0(horizontal midpoint)
Trigger System	Hold-off time	100.00ns
	Trigger type	Edge
	Source	CH1
	Slope type	Rising
	Coupling mode	DC
	Trigger mode	Automatic
Display	Type	Vector
	Format	YT
	Duration time	The minimum
	Grid brightness	40%
	Waveform brightness	50%
	Background brightness	50%
	Transparence	ON
Other System	Storage type	Waveform
	Frequency meter	ON
	Measurement	OFF, clear all measurement
	Cursor	OFF
	Language	Keep the settings before shutdown
	Menu display	Manual
	Square wave output	1 kHz
	Output selection	Trigger
	Sampling mode	Normal
	Storage depth	Auto

16. System Prompt and Troubleshooting

16.1 Description of system prompt

16.2 Troubleshooting

16.1 Description of System Prompt

This chapter is to describe the system prompt, the detailed explanation as shown in Figure 16-1.

Table 16-1

Adjusting is up to extremity!	It is prompt that the adjusting is up to extremity in the current status. It cannot be adjust. It will be prompt when timebase rotary knob, horizontal displacement, vertical displacement, trigger level, trigger time is up to extremity.
Saving, please wait...	It will be prompt when save waveform and the setting file.
Loading, please wait...	It will be prompt when recall the setting file.
Storage is succeed.	It will be prompt when save waveform, the setting file, decoding data is succeed.
Storage is failed.	It will be prompt when save waveform, the setting file, decoding data is failed.
The setting is succeed.	It will be prompt when recall the reference waveform and the setting file is set successfully.
The setting is failed.	It will be prompt when fail to set recall the reference waveform and the setting file.
The factory setting is succeed.	It will be prompt when the Default function is enabled.
The signal is not detected.	It will be prompt when AUTO operating is performed but no input signal.
In XY mode, this function is forbidden.	It will be prompt when turn on extend window in XY mode.
In FFT mode, this function is forbidden.	It will be prompt when opening FFT, entering waveform recording, pass test and open the bus.
In waveform recording, this function is forbidden.	It will be prompt when switch the storage depth in waveform recording.
In recording, please exit the record!	It will be prompt when switch the extend window in waveform recording.
Detect USB device is failed!	It will be prompt when plug in USB, USB identify failed and plug out when USB loading the setting file.
USB device is removed.	It will be prompt when USB is plug out.

In extend timebase, this function is forbidden.	It will be prompt when turn on extend timebase and pass test.
In Multi-Scopes, this function is forbidden.	It will be prompt when using auto-calibration, extend window, recording waveform, pass test, MATH, open XY and DECODE function in Multi-Scopes.
PrintScreen is succeed.	It will be prompt when PrtSc is succeed.
PrintScreen is failed.	It will be prompt when PrtSc is failed.
Invalid expression !	It will be prompt when expression is invalid in MATH advanced operation.
IP address is configured succeed.	It will be prompt when IP address is configured succeed.
IP address is configured failed.	It will be prompt when IP address is configured failed.
Automatic configure IP address, please wait...	It will be prompt when adjust IP type to DHCP.
Clearing the data, please wait...	It will be prompt when using the clear data function.
Data is successful deleted.	It will be prompt when clear data is completed.
User-defined is successful deleted.	It will be prompt when the user-defined parameter is cleared.
The system is shutting down...	It will be prompt when the oscilloscope is shutting down.
This function is invalid when it in STOP !	It will be prompt when turn on/off Multi-Scopes, switch storage depth and sampling mode, XY function in STOP state.
Automatic setting is completed.	It will be prompt when automatic setting is completed.
Turn on reference channel	It will be prompt when select a not open channel during creating template in Pass test mode.
Press RUN/STOP to stop the operating.	It will be prompt when using Multiple function rotary knob to adjust the value of chip selection in FFT-waterfall curve.
Input parameter is invalid !	It will be prompt when input parameter via the soft keypad is not within input range.
Channel is not open !	It will be prompt when channel is not open, waveform storage, vertical movement, horizontal movement, adjusting timebase scale, adjusting volts/div scale and adjusting trigger level.
Exceed the maximum limit !	It will be prompt when the input character of File name (storage waveform, the setting file, decoding data) is exceed 12.

No record waveform !	It will be prompt when no recording data, play waveform, stop the operating.
No user-defined parameter !	It will be prompt when open measurement statistics but no user-defined parameter.
In MultiScope, this function is forbidden.	It will be prompt when using auto-calibration, recording waveform and pass test in Multi-Scopes.
Keypad is locked.	It will be prompt when open the upper computer.
Keypad is unlocked.	It will be prompt when cut-off the upper computer.
Input the file name.	It will be prompt when confirm the input file name.
The file list is empty.	It will be prompt when recall the reference waveform and the setting file, the recall list is empty.
In roll mode, this function is forbidden.	It will be prompt when turn on extend timebase, XY, waveform storage, recording waveform, Pass test and MATH in ROLL mode.
In MultiScope, this function is forbidden.	It will be prompt when using extend window, MATH, open XY and DECODE function in Multi-Scopes.
In DHCP mode, key is not worked.	It will be prompt when confirm IP configuration in DHCP mode.
Invalid subnet mask.	It will be prompt when the subnet mask value is out of 255.255.255.0.
Auto-calibration is failed.	It will be prompt when the auto-calibration is failed.
Auto-calibration is succeed.	It will be prompt when the auto-calibration is completed and succeed.
Exit the recording.	It will be prompt when press RUN/STOP key during recording waveform or the record is completed.
Recording is completed.	It will be prompt when press RUN/STOP key during recording waveform or the record is completed.
In FFT mode, cursor is forbidden. Please use FFT marker function.	In FFT, It will be prompt when using the CURSOR function.
In FFT split mode, this function is forbidden.	In FFT split screen, it will be prompt when turn on XY.
Stop Pass/Fail function.	It will be prompt when the pass test is closed.
MultiScope is loading, please wait...	It will be prompt when turn on Multi-Scopes.
EXIT MultiScope, please wait...	It will be prompt when turn off Multi-Scopes.

18.2 Troubleshooting

- (1) When press the button, the oscilloscope is blank screen.
 - a. Check whether the power is correctly connected, power supply is normal or not.
 - b. Check whether the power switch is really turned on. The soft power switch button should light in green when the instrument is normal boot. And it should have relay sound.
 - c. If there is a relay sound, it indicates that the oscilloscope starts normally.
Try the following steps: press the DEFAULT key, then press F1, if device returns to normal, it means backlight brightness is set too low.
 - d. After completing the above steps, restart the oscilloscope.
 - e. If the instrument still cannot work, please contact UNI-T.
- (2) After signal acquisition, signal of waveform does not appear on the screen.
 - a. Check whether BNC port is connected properly.
 - b. Check whether the signal output channel has turned on.
 - c. Check whether the input signal channel has turned on.
 - d. Check whether has frequency displacement in signal of information source.
 - e. Plug out the input signal, check whether the baseline is in the screen range (if not, please perform auto-calibration.)
 - f. If the instrument still cannot work, please contact UNI-T.
- (3) The measured voltage amplitude value is 10 times larger or smaller than the actual value: Check the channel probe attenuation coefficient setting is consistent with the used probe attenuation rate.
- (4) There is a waveform display but not stable
 - a. Check the trigger source in the trigger menu and confirm that it matches the input channel of the actual signal.
 - b. Check the trigger type: general signal should use “Edge” trigger. The waveform can display stably only the proper trigger type is used.
 - c. Change the trigger coupling setting to high-frequency or low-frequency, in order to filter out the high-frequency or low-frequency noise that interferes with the trigger.
- (5) No display after pressing **Run/Stop** button
 - a. Check whether the mode at the trigger panel (TRIGGER) is on “Normal” or “Single” and whether the trigger level exceeds the waveform range.
 - b. If it exceeds, set the trigger level to the middle or set the trigger mode to **Auto**.
 - c. Press **AUTO** button could automatically finish the above setting.
- (6) Waveform refresh is very slow
 - a. Check whether the acquisition method is average and the average times are large.
 - b. Check whether the holdoff time is large.
 - c. Check whether is single trigger and the current setting is slow timebase scale.
 - d. The above will cause slow refreshing of the waveform. It is advised to restore the factory setting. Waveform can be refresh normally.

17. Appendix

Appendix A Maintenance and Cleaning

(1) General Maintenance

Keep the instrument away from the direct sunlight.

Caution

Keep sprays, liquids and solvents away from the instrument or probe to avoid damaging the instrument or probe.

(2) Cleaning

Check the instrument frequently according to the operating condition. Follow these steps to clean the external surface of the instrument:

- a. Please use a soft cloth to wipe the dust outside the instrument.
- b. When cleaning the LCD screen, please pay attention and protect the transparent LCD screen.
- c. When cleaning the dust screen, use a screwdriver to remove the screws of the dust cover and then remove the dust screen. After cleaning, install the dust screen in sequence.
- d. Please disconnect the power supply, then wipe the instrument with a damp but not dripping soft cloth. Do not use any abrasive chemical cleaning agent on the instrument or probes.

Warning

Please confirm that the instrument is completely dry before use, to avoid electrical shorts or even personal injury caused by moisture.

Appendix B Warranty Overview

UNI-T (UNI-TREND TECHNOLOGY (CHINA) CO., LTD.) ensures the production and sale of products, from authorized dealer's delivery date of three years, without any defects in materials and workmanship. If the product is proven to be defective within this period, UNI-T will repair or replace the product in accordance with the detailed provisions of the warranty.

To arrange for repair or acquire warranty form, please contact the nearest UNI-T sales and repair department.

In addition to permit provided by this summary or other applicable insurance guarantee, UNI-T does not provide any other explicit or implied guarantee, including but not limited to the product trading and special purpose for any implied warranties.

In any case, UNI-T does not bear any responsibility for indirect, special, or consequential loss.

Appendix C Contact Us

If the use of this product has caused any inconvenience, if you in mainland China you can contact UNI-T company directly.

Service support: 8am to 5.30pm (UTC+8), Monday to Friday or via email. Our email address is infosh@uni-trend.com.cn

For product support outside mainland China, please contact your local UNI-T distributor or sales center.

Many UNI-T products have the option of extending the warranty and calibration period, please contact your local UNI-T dealer or sales center.

To obtain the address list of our service centers, please visit our website at URL: <http://www.uni-trend.com>