

UNI-T®

Instruments.uni-trend.com

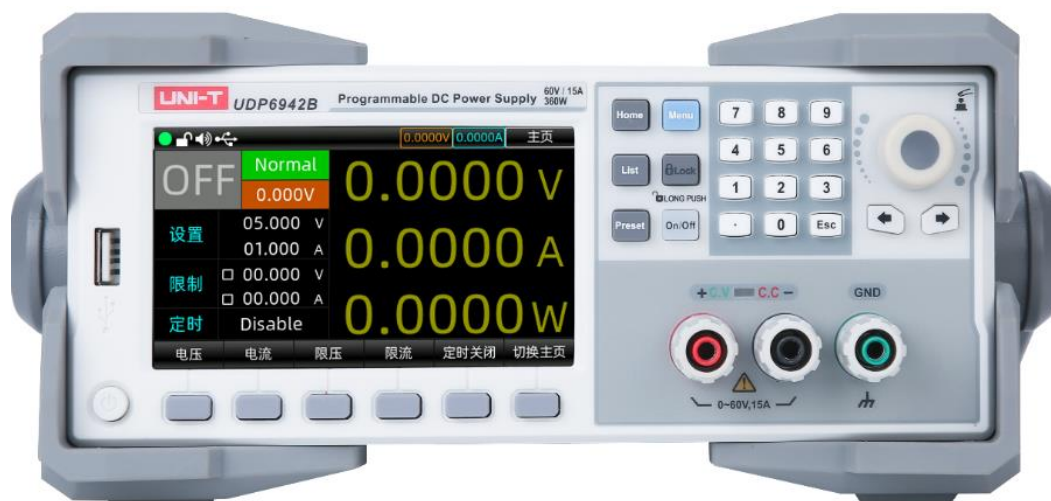

User's Manual

UDP6900 Series Digital Control Power Supply

Perface

Thank you for choosing this brand new UNI-T instrument. In order to use this instrument safely and correctly, please read this manual thoroughly, especially the Safety Requirements part.

After reading this manual, it is recommended to keep the manual at an easily accessible place, preferably close to the device, for future reference.

Copyright

Copyright is owned by Uni-Trend Technology (China) Co., Ltd.

UNI-T products are protected by patent rights in China and other countries, including issued and pending patents. Uni-Trend reserves the rights to any product specification and pricing changes.

Uni-Trend Technology (China) Co., Ltd. all rights reserved. Trend reserves all rights. Information in this manual supersedes all previously published versions. No part of this manual may be copied, extracted or translated by any means without the prior permission of Uni-Trend.

UNI-T is the registered trademark of Uni Trend Technology (China) Co., Ltd.

Warranty Service

The instrument has a warranty period of three years from the date of purchase. If the instrument is damaged due to improper operation by the user during the warranty period, the maintenance fee and the costs caused by the maintenance shall be borne by the user, and the instrument shall be maintained by the company for life.

If the original purchaser sells or transfers the product to a third party within one year from the date of purchase of the product, the warranty period of one year shall be from the date of the original purchase from UNI-T or an authorized UNI-T distributor. Power cords, accessories and fuses, etc. are not included in this warranty.

If the product is proved to be defective within the warranty period, UNI-T reserves the rights to either repair the defective product without charging of parts and labor, or exchange the defected product to a working equivalent product (determined by UNI-T). Replacement parts, modules and products may be brand new, or perform at the same specifications as brand new products. All original parts, modules, or products which were defective become the property of UNI-T.

The "customer" refers to the individual or entity that is declared in the guarantee. In order to obtain the warranty service, "customer" must inform the defects within the applicable warranty period to UNI-T, and perform

appropriate arrangements for the warranty service.

The customer shall be responsible for packing and shipping the defective products to the individual or entity that is declared in the guarantee. In order obtain the warranty service, customer must inform the defects within the applicable warranty period to UNI-T, and perform appropriate arrangements for the warranty service. The customer shall be responsible for packing and shipping the defective products to the designated maintenance center of UNI-T, pay the shipping cost, and provide a copy of the purchase receipt of the original purchaser. If the products is shipped domestically to the purchase receipt of the original purchaser. If the product is shipped to the location of the UNI-T service center, UNI-T shall pay the return shipping fee. If the product is sent to any other location, the customer shall be responsible for all shipping, duties, taxes, and any other expenses.

Limited Warranty and Liability

The warranty is inapplicable to any defects, failures or damages caused by accident, normal wear of components, use beyond specified scope or improper use of product, or improper or insufficient maintenance.

UNI-T is not obliged to provide the services below as prescribed by the warranty:

- a) Repair damage caused by installation, repair or maintenance of personnel other than service representatives of UNI-T;
- b) Repair damage caused by improper use or connection to incompatible equipment;
- c) Repair any damages or failures caused by using power source not provided by UNI-T;
- d) Repair products that have been changed or integrated with other products (if such change or integration increases time or difficulty of repair).

The warranty is formulated by UNI-T for this product, replacing any other express or implied warranties. UNI-T and its distributors refuse to give any implied warranty for marketability or applicability for special purpose. For violation of the warranty, repair or replacement of defective products is the only and all remedial measure UNI-T provides for customers.

No matter whether UNI-T and its distributors are informed of any possible indirect, special, occasional or inevitable damage in advance, they assume no responsibility for such damage.

Safety Information

 Warning  Caution







To avoid possible electric shock and personal safety, please follow the instructions below. Users must follow the following conventional safety precautions in operation, service and maintenance of this device.

UNI-T will not be liable for any personal safety and property loss caused by the user's failure to follow the

following safety precautions.

Instrument ground	Please use the cable provided by the factory to connect device. To avoid electric shock, the ground cable must connect correctly.
Operating voltage	Please make sure the operating voltage not over the rated range of 10%, to avoid damage to the instrument.
Input voltage	Please use AC 110V~220V 50/60Hz AC power supply, use national approved power cord and make sure insulating layer is in good condition.
Inspecting test lead wire	Inspecting the insulated layer of the test lead wire whether is damaged or the wire bareness, or the test lead wire is breakover. If the test lead wire is damaged, please replace it before use the instrument.
Fuse	Only allowed to use the specified fuse of the product.
Over voltage protection	Please make sure the instrument is not over-voltage (such as the voltage caused by thunder), to prevent operating personnel away from electric shock.
Do not open the cover during operating	Do not operate the instrument when open the instrument cover, and do not change the internal circuit.
Do not contact live part	When the instrument is operating, do not touch exposed connecting wire, not used input port and the circuit during testing. Please caution to the electric shock when testing the voltage is over DC 60V or AC 30V.
Do not operate in flammable and explosive environment	Do not use this device in a flammable and explosive or dusty, high temperature and humidity and strong electromagnetic environment to avoid product damage or personal injury.

Safety Sign

	Ground		On (power)
	Protective ground		Off (power)
	Signal ground		Connect with Cabinet or Case
	Danger mark		

Environment-friendly Use Period



This environment-friendly use period (EFUP) mark indicates that dangerous or toxic substances will not leak or cause damage within this indicated time period. The environment-friendly use period of this product is 40 years, during which it can be used safely. Upon expiration of this period, it should enter the recycling system.

WEEE Directive (2002/96/EC)



This additional label indicates that this electrical / electronic product must not be discarded in household waste.

Operating Environment

UDP6900 series digital control power supply can only be used under room temperature and low non-condensing zone. The general environmental requirements of the instruments is listed as the below table.

Operating Environment	Requirements
Operating temperature	0°C~40°C
Operating humidity	20%~80% (non-condensation)
Storage temperature	-10°C~70°C
Altitude	≤2000 meters
Pollution degree	2

Cleaning

Please pull out power line before cleaning to avoid electric shock.

Please use a clean cloth dipped in clean water to clean the cover and panel.

The instrument should keep dry and do not let water into the internal.

Do not clean the inside of the instrument.



Caution: Do not use solvents (alcohol or gasoline etc.) to clean the instrument.

1. Inspection and Installation

1.1 Packing List

Before using the instrument,

1. Check the appearance whether is damaged or scratched;
2. Check the packing list if has loss.

If the product is damaged or accessory is missing, please contact UNI-T sales department or distributor.

Article	Quantity	Remarks
UDP6900 series DC Digital Control Power	1 piece	The model is subject to the actual order.
3C power cable	1 piece	
Calibration report	1 piece	Calibration report of product
User's manual/PC software	/	Electronic user's manual can download from the official website.
USB data wire	1 piece	



Explanation

Please keep the packing box and the relevant articles for returned to the factory service.

1.2 Installing Power Supply

Model of UDP6922B/UDP6932B/UDP6933B/UDP6942B/UDP6952B/UDP6953B

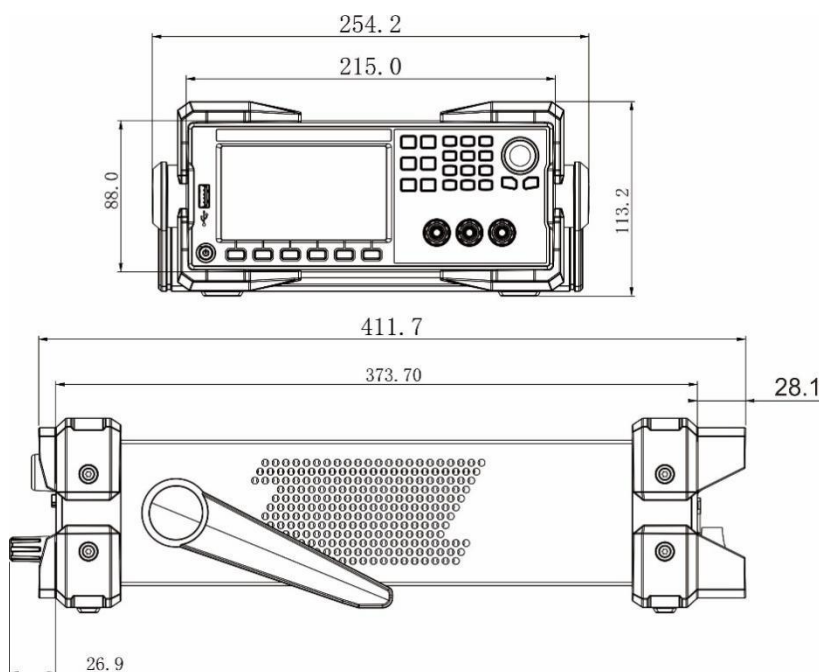

Dimension Figure

1.3 Handle

Handle can adjust to three positions by appropriate strengths.

Hold the handle and pull to two sides to remove it. Adjusting the handle to the position as shown in the following figure.

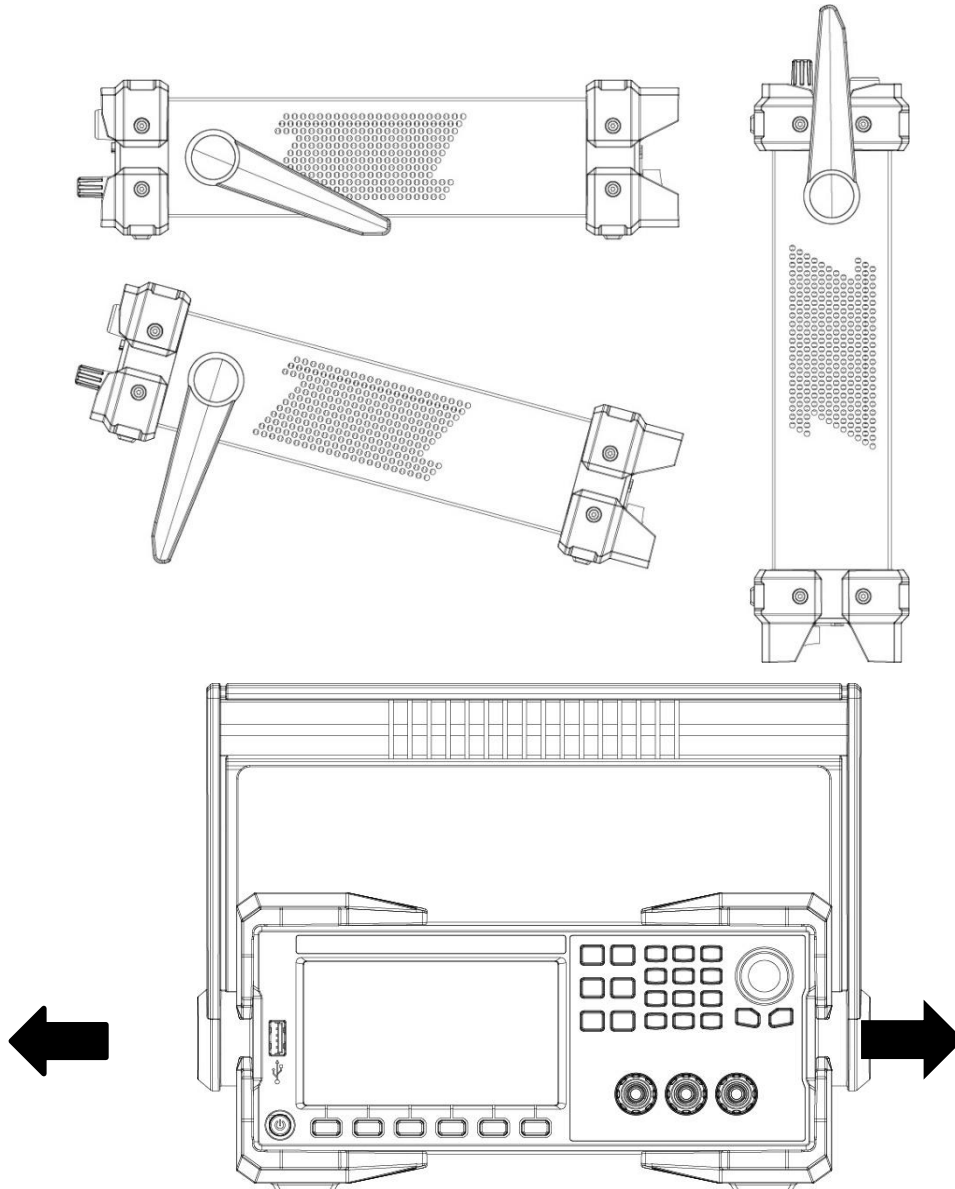

✦ Explanation

Be careful of your hands when remove the handle.

1.4 Connecting Power Cable

Connecting the assembled power cable to power supply, the power supply can support operating voltage between 110V~220V.

Input class of AC power supply

- ◆ Option Opt.01: 220VAC \pm 10%, 47 to 63 Hz
- ◆ Option Opt.02: 110 VAC \pm 10%, 47 to 63 Hz

2. Quick Guide

This chapter briefly introduces the front panel, rear panel, keyboard function and LCD display function of UDP6900 series power supply. To ensure that user can quickly understand the appearance, structure and key function of the power supply before operating the power supply, it can help you better use this series of power supply.

2.1 Product Introduction

UDP6900 series is single output programmable DC power supply. This series can realize all sorts of combined output of voltage and current in rated power. A single power supply can meet the two kinds of objects to be tested, high voltage and low current or high current and low voltage test, which greatly saves your cost and space. Take UDP6942B (60V/15A/360W) as an example, it can realize various combination of 60V/6A/360W, 40V/9A/360W and 24V/15A/360W.

UDP6900 series has a built-in interface of RS232, RS485, USB and analog quantity. It supports SCPI protocol for remote control, PLC control and setting up an intelligent test platform. It widely used in DC-DC power module, battery charging and sensor and other testing fields.

Main features and strengths

- ❓ 4.3" TFT true color LCD, simultaneous display the set voltage and current, output voltage and current
- ❓ High accuracy and resolution
- ❓ Output the voltage and current by the program
- ❓ Output time control can be set (0.1~99999.9 seconds)
- ❓ Low ripple and noise
- ❓ Voltage can current can adjust by the numeric keyboard and the encoder knob
- ❓ Intelligent fan control for save energy
- ❓ Remote sense
- ❓ RS232 & RS485 communication interface; SCPI, Multi-SCPI and Modbus RTU protocol
- ❓ External analog control and external digital control
- ❓ Built-in 4 1/2 digit voltmeter/ammeter for outside measurement
- ❓ Multiple protection: OVP, OTP and OCP
- ❓ Supports 18x8 group for save and load
- ❓ High power factor, low harmonic interference to the power grid, ideal for applications with high power quality

- ❑ High efficiency
- ❑ Front and rear panel are both supported to output
- ❑ Output of current, voltage and power figure is clearly visible
- ❑ LAN port supports Web remote control and VXI bus
- ❑ Supports 100 to 240V input voltage

Model	Voltage	Current	Power
UDP6922B	60V	5A	100W
UDP6932B	60V	10A	200W
UDP6933B	150V	5A	200W
UDP6942B	60V	15A	360W
UDP6952B	60V	25A	600W
UDP6953B	150V	10A	600W

2.2 Front Panel

Front panel of UDP6922B/UDP6932B/UDP6933B/UDP6942B/UDP6952B/UDP6953B

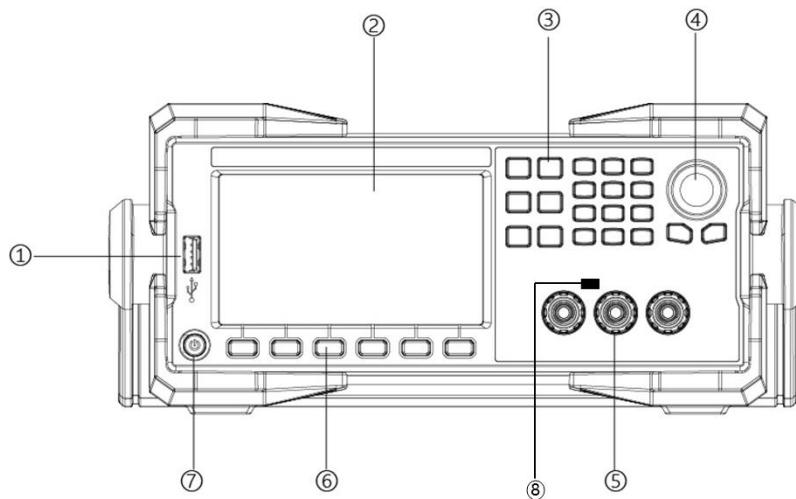

1. USB 2.0 Host port
2. 4.3 inch true color LCD
3. Function settings and numeric keyboard
4. Encoder knob
5. Output terminal
6. Selection key
7. AC power switch
8. CC/CV indicator

2.3 Keyboard

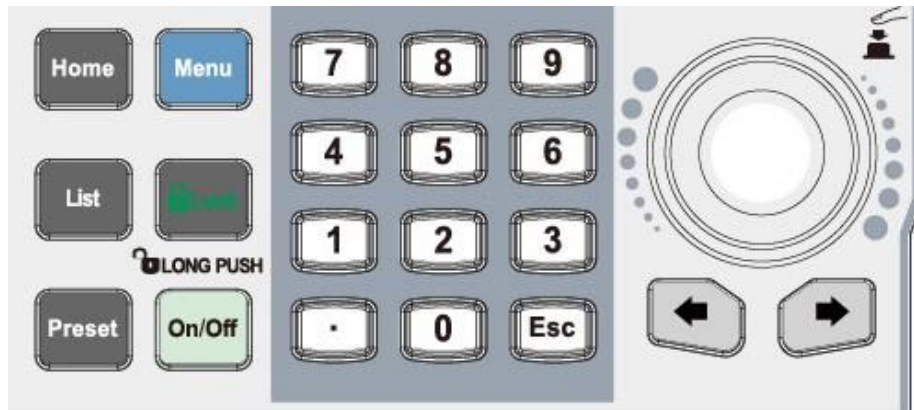

Key	Function
Home	The home page is for displaying the output waveform and switching to a big front.
Menu	The menu page is for settings, long press screenshot monitor, output settings, system settings, user's group management; Long press to save the current page to USB memory when USB is connected.
List	Enable and switch list output or delay function.
Lock	Short press to lock, long press to unlock the keyboard.
Preset	Save the output settings, it can be directly loaded.
On/Off	Turn on/off power output
Numeric keyboard	Set input value of the parameter
← →	Arrow key is for switching step digit of the parameter.
Recoder knob	Selecting and editing the numerical value. Short press the key is used to "Enter/Confirm".
ESC	Return to up one level/exit data editing

2.4 LCD

Take the home page as an example to introduce icon and character functions.



Icon and Character	Description	Icon and Character	Description
	Blinking represents that in sampling.		Volume key is enabled.
	Panel lock is enabled.		Connecting network cable
	USB is plug-in and recognized.		Display the output voltage.
	Display the output current.		Display the reading when the voltmeter function has been used.
Normal	The power operating mode is normal	CC	The output mode is CC (constant current).
CV	The output mode is CV (constant voltage).	Disable	Timer is disabled.
OFF	Turn off the output.	ON	Turn on the output.
OVP	OVP is activated, the output will be turned off.	OCP	OCP is activated, the output will be turned off.
OTP	OTP is activated, the output will be turned off.	Error	Power failure

2.5 Rear Panel

Rear panel of UDP6922B/UDP6932B/UDP6933B/UDP6942B/UDP6952B/UDP6953B

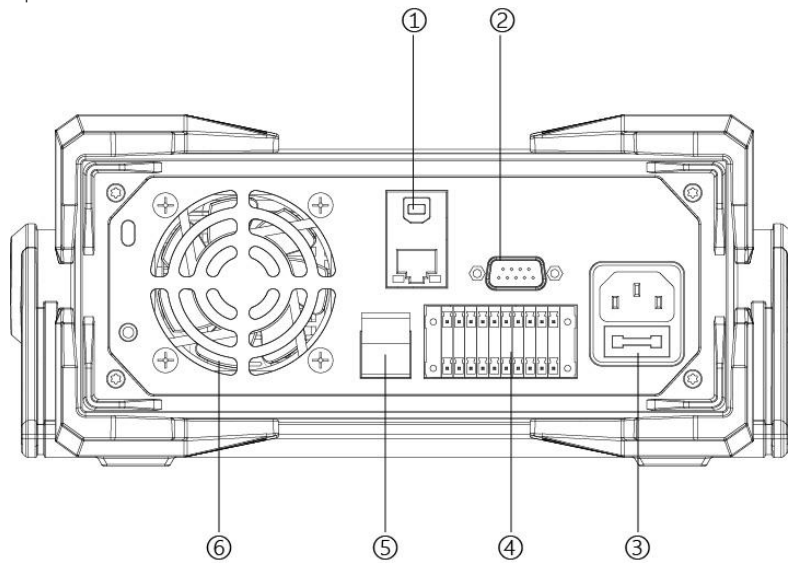

1. USB TMC Device and LAN port
2. RS232 communication port
3. AC power input socket (it contains the fuse)
4. RS485 communication port and multiple measurement port
5. Output terminal on the rear panel
6. Cooling fan

2.6 Power-on Self-inspection

Successful self-inspection represents that the product meets the factory standard and it can be used normally. Before operating the power supply, please make sure that you have fully understood the safety instructions.

Warning

Please make sure the power voltage meets the power supply, otherwise the power supply may be burned out.

Please make sure the main power plug connects to the protective power socket. Do not use a power strip without protective ground. Check the power ground is in good condition before operating the power supply.

Please note the positive and negative identification before wiring, otherwise the power supply may be burned out.

Self-inspection Steps

1. Correctly connect the power cable, press the power switch to power on and then the power supply will start to self-inspection.
2. After the self-inspection is finished, LCD will be normally display the voltage and current

on home page.

Error Reference

- If EEPROM is damaged, "EEPROM Fault" will be prompted.

Trouble-shooting

The power supply fails to start properly when the power supply is enabled, see the following procedure to check and deal with it.

1. Check whether the power cable is connected correctly and make sure the power supply is powered on.

If the power cable is connected in good condition, then move to next step.

If the power cable is connected incorrectly, reconnect the power cable to fix the error.

2. Check whether the power supply is turned on and the power switch is switched on. If the power supply has been turned on and the power switch is switched on, then move to next step.

If the power supply is turned off, press the power switch to fix the error.

3. Check whether the fuse is burned out.

If the fuse is burned out, replace the fuse as the following steps.

- (1) Turn off the power supply and plug out the power cable, use tweezers or screwdriver to take out the fuse box (fuse position refer to Rear Panel figure).
- (2) Check whether the fuse is damaged, if it is really damaged, replace the fuse according to the model.

The specification of fuse as shown in the following table.

Model	Specification of Fuse (Input 110VAC~220VAC)
UDP6922B	250V/F3.15A
UDP6932B	250V/F5A
UDP6933B	250V/F5A
UDP6942B	250V/F6.3A
UDP6952B	250V/F10A
UDP6953B	250V/F10A

- (3) Replace the fuse of the same specification, put it in the box, and re-power it.

3. Function and Feature

This chapter is to introduce the function and feature of the power supply, including the following contents.

- Local/Remote
- Voltage Settings
- Current Settings
- Output ON/OFF
- Key Lock
- Voltage, Current and Power Settings
- Output Preset Settings
- Over-voltage Protection (OVP) Settings
- Over-current Protection (OCP) Settings
- Page Switching
- List and Delay Functions
- Main Menu
- Terminal Functions of Rear Panel

3.1 Local/Remote







The power supply supports two kinds of operating mode, local and remote. The two mode can be switched by communication command. The default mode is local.

- Local mode: use the keyboard on the instrument to operating
- Remote mode: the power supply connects to PC and use PC to control the power supply

3.2 Voltage Settings

The voltage range is between 0V to the maximum output. When press the voltage key , the cursor indicator will move to the voltage field, as shown in the following figure.

There are two ways to adjust the voltage output value.

1. When the power supply is enabled, press the voltage key  (label 1 as shown in the following figure), use arrow keys  (label 2 as shown in the following figure) to move the cursor to the specified position and rotate the encoder knob to adjust the voltage value, and then push the encoder knob  one time to confirm ((label 3 as shown in the following figure).
2. When the power supply is enabled, press the voltage key  (label 1 as shown in the following figure), use numeric keyboard to input the voltage value, if the input is wrong, press the left key  (label 2 as shown in the following figure) to delete bit-by-bit. Push the encoder knob  one time to confirm ((label 3 as shown in the following figure).

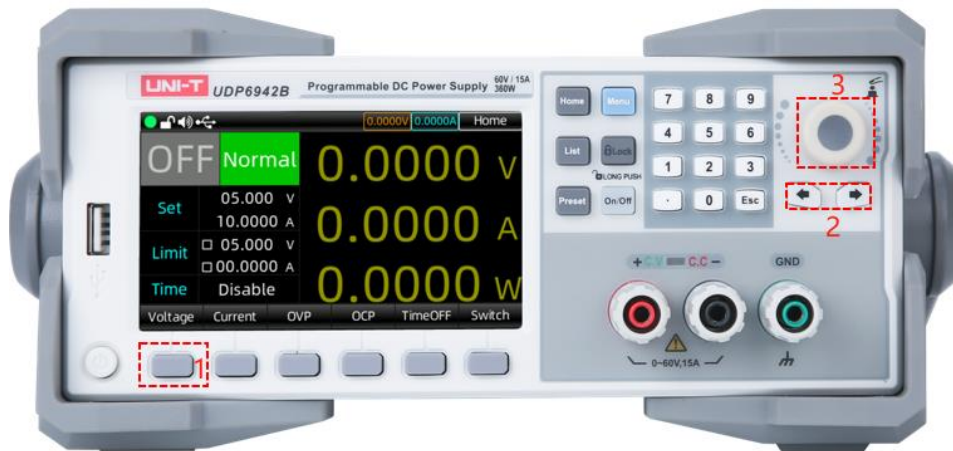

3.3 Current Settings

The current range is between 0V to the maximum output. When press the current key , the cursor indicator will move to the current field, as shown in the following figure.

The step of current settings is the same as the voltage settings.

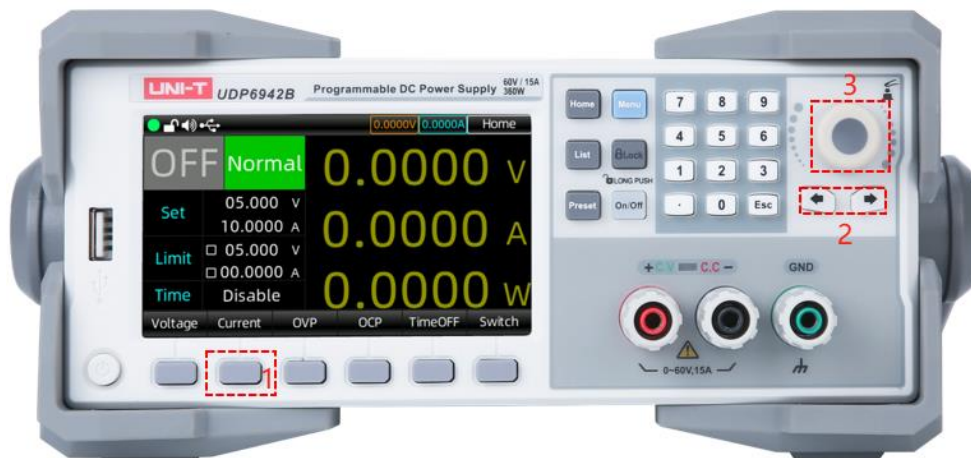

3.4 Output ON/OFF

Press the output key  to turn on the function and the indicator is green. The user's page will highlight to display the output voltage, current, ON/OFF state, power and output mode (CV/CC).

- ★ Explanation: Press the output key  when the power supply is connected to the object under test. Otherwise, it is easy to ignite when wiring. If the output function has been turned on but no power output, please check the voltage settings and set the voltage and current to non-zero value, and then turn on the output function.

3.5 Key Lock

The keypad lock function can prevent unauthorized personnel or operators from disoperation, so as not to cause damage to the object to be measured.

Press the Lock key  lightly to activate the key lock function, the Lock key will be illuminated with a green light, and the status display bar on the top of the screen will have the Lock indication mark, at this time, the keyboard is locked to avoid misuse.

In the lock state, long press the Lock key to activate the unlock function, the key indicator will be extinguished, and the status display bar on the top of the screen will have the Unlock indication mark , at this time, the keyboard is allowed to use.

3.6 Voltage, Current and Power Settings

The output voltage of the power supply and the resistance of the load determine the output current. If the output current is lower than the set current limit, the product operates in constant voltage (CV) mode and is indicated by the CV status text.

If the output current is limited by the current settings value or rated current, the product switches to constant current mode (CC) and is indicated by the CC status text. The maximum power of the power supply will limit the voltage and current settings, and the product of voltage and current cannot be greater than the maximum output power of the device.

Take UDP6942 (60V/15A/360W) as an example, when the set voltage value is 10V, the current value is 10A, at this time, the output power is 100W; when the set voltage value is 30V, the current value is 15A, due to the limitation of the rated power of 360W, the voltage is 30V and the set current value automatically jumps to 12A.

3.7 Output Preset Settings

UDP6900 series power supply provides 8 groups of output preset functions which can be edited and stored freely. Users can preset the voltage value, current value, limit voltage value and limit current value according to their needs. Load the parameters to use, save the reset the step of the parameter. Preset function page is shown in the following figure.



No	Volt(V)	Curr(A)	OVP(V)	OCP(A)	TimeOff(s)
0	20.000	05.0000	05.000X	00.0000X	00000.5X
1	20.000	05.0000	05.000X	00.0000X	00000.5X
2	00.000	00.0000	00.000X	00.0000X	00000.0X
3	00.000	00.0000	00.000X	00.0000X	00000.0X
4	00.000	00.0000	00.000X	00.0000X	00000.0X
5	00.000	00.0000	00.000X	00.0000X	00000.0X
6	00.000	00.0000	00.000X	00.0000X	00000.0X
7	00.000	00.0000	00.000X	00.0000X	00000.0X







Preset Function Page

Operation Steps

1. Press the power switch to turn on the instrument;

2. Press the "Preset" key on the panel, the screen displays the output preset interface;
3. Use the encoder knob to switch the preset parameter group, press the "Edit" key to edit the selected parameter;
4. When the loaded preset group is edited, press the **ESC** key to exit the editing page;
5. Explanation of key
 - a. Load: short press to load the set value and automatically jump to the display page of read-back waveform.
 - b. Storage: long press to save the output voltage and current, limit voltage and current and time control settings to the selected position.





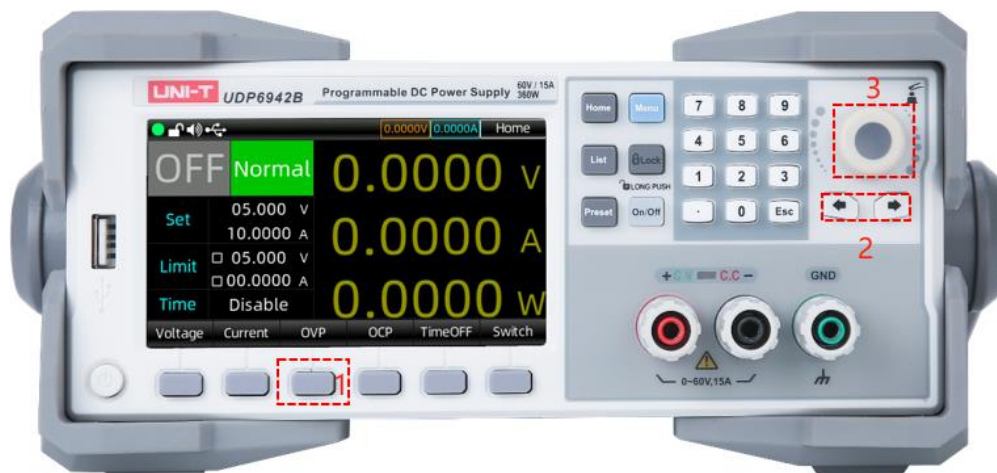

3.8 Over-voltage Protection (OVP) Settings

Press the voltage key  slightly (Label 1 as shown in the following figure), move the voltage protection value to the voltage protection value setting column, use the arrow key   with the encoder knob to switch to the set value or use numeric keyboard to input the set value, push the encoder knob one time, the icon  represents the voltage protection value is set successfully. If you want to turn off the OVP function, press the voltage key  slightly two times (Label 1 as shown in the following figure), and the tick  will be disappeared.





3.9 Over-current Protection (OCP) Settings

The set steps of OCP settings is the same as OVP settings.

Press the current key  slightly, move the current protection value to the current protection value setting column, use the arrow key   with the encoder knob to switch to the set value or use numeric keyboard to input the set value, push the encoder knob one time, the icon  represents the current protection value is set successfully. If you want to turn off the OCP function, press the current key  slightly two times, and the tick  will be disappeared.

3.10 Main Page Switching

UDP6900 series has main page switching function.

Press the menu key  slightly (Label 1 as shown in the following figure) or the Home key  to switch the page.

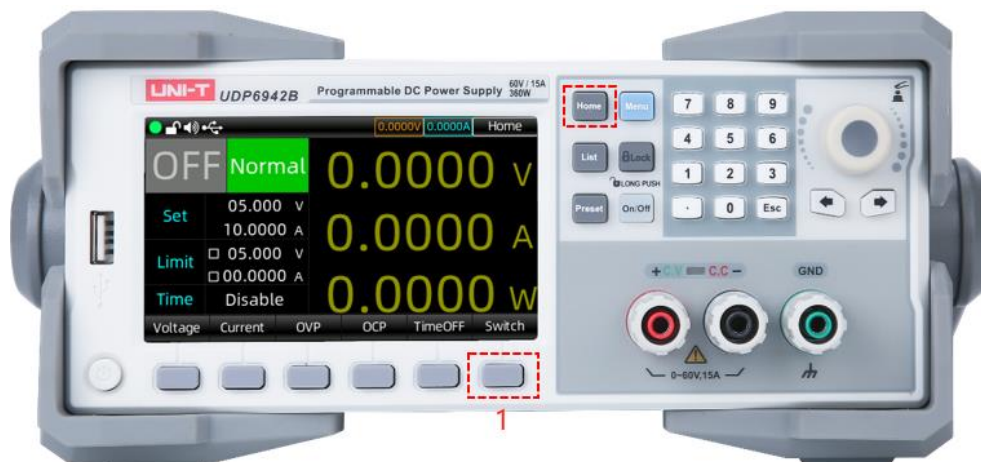

3.11 List Output (Time Control) and Delayer Function

UDP6900 series provides list and delayer function.

List output can successively output the user-defined parameter group (512 groups at most), output voltage, output current and time. User can change the parameter group by manual or use the template to batch set the parameter group.

Delayer can successively output the user-defined switch sequence group (512 groups at most), output switch and time. User can change the parameter group by manual or use the template to quickly generate the switch sequence.

List output and delayer can manually both load and save the specified file from the internal Flash storage or external USB storage. The storage format is (.lst.csv) and (.dly.csv). User can directly open and quickly edit the EXCEL file on computer.

3.11.1 List Output Settings

1. Press the List key  on the panel to enter List Output page;
2. Click on the basic setting to set the start point, count, times and stop state. The maximum sum of the start point and the count is 512.
The cycle count can set to 1 to 99999 or "Inf";
3. Click on the Edit button to set the parameter of each point or it can set by Template in batches;
4. Enable: when the list output starts to operating, the output will stop when it meets the condition or is stopped manually.
Note: Press the On/Off key during the operation, the list output will be paused, press it again to continue the output.
5. Click on the Manage button to select the file to save or input the filename and save to the specified storager;
Note: List output data is not saved automatically and needs to be saved manually.



Stopped		No	Volt(V)	Curr(A)	kT(s)
Current	000	509	00.000	00.0000	0.1
Looped	000	510	00.000	00.0000	0.1
Start	000	511	00.000	00.0000	0.1
Groups	512	0	00.000	00.0000	0.1
Cycles	Inf	1	00.000	00.0000	0.1
		2	00.000	00.0000	0.1
		3	00.000	00.0000	0.1
EndState	OFF	4	00.000	00.0000	0.1

Option Edit Start Manage Template

List Output Page

Template Settings

Press Template to enter the following page.

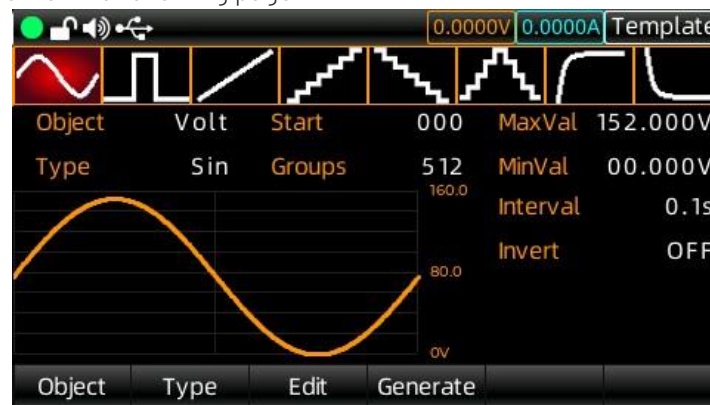

1. Click on the Edit Object button to switch to voltage or current;
2. Click on the Type button to switch to template of wave;
3. Click on the Edit button to set the start point and total point of generated wave;
4. Click on the Edit button to set the maximum and minimum of voltage and current, high-low level, pulse width, period, phase of the waveform;
5. After the above settings is finished, click on the Generate button to complete the wave output settings.

Template Parameter

Template parameter includes sine wave, pulse wave, ramp wave, step rising wave, step falling wave, staircase wave, exponential rising wave and exponential falling wave.

1. Sine Wave

The maximum and minimum determines the amplitude of the sine wave.

The total count (maximum 2048) and the time interval (maximum 9999.9) determines the period of the sine wave.

After the wave is created, set cycle times in list output mode to output the sine wave continuously. Output time is determined by the product of the period and cycle times.

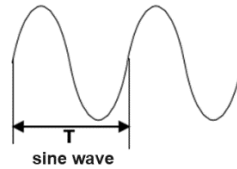

2. Pulse Wave

Pulse width t determines the duration of the high level, period T determines the duration of the whole pulse. The duration of the low level acquired by period T minus pulse width t . The maximum and the minimum amplitude of the pulse is decided by the high level and the low level.

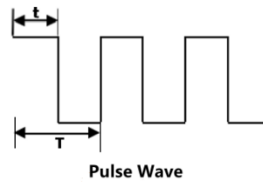

3. Ramp Wave

The difference between the maximum and minimum values and the time interval (maximum 9999.9) determines the slope of the ramp wave.

The symmetry defines the proportion of the rising time of the ramp wave in the whole period. The falling time of the ramp is equal to the period minus the product of the period and the symmetry.

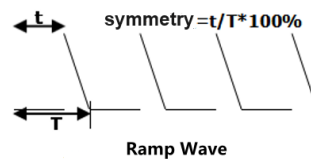

4. Step Rising Wave

The maximum and minimum of the wave determines the amplitude of the step rising wave.

Total count (denoted as N) will divide the amplitude to $N-1$ of step.

The time interval (maximum 9999.9) represents the duration of each step. The time interval and the total count determines the wave period.

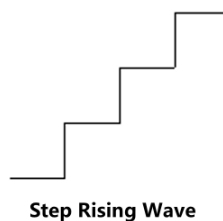

5. Step Falling Wave

The maximum and minimum of the wave determines the amplitude of the step falling wave.

Total count (denoted as N) will divide the amplitude to N-1 of step.

The time interval (maximum 9999.9) represents the duration of each step. The time interval and the total count determines the wave period.

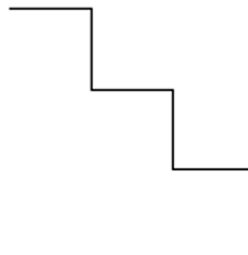

Step Falling Wave

6. Staircase Wave

The maximum and minimum of the wave determines the amplitude of the staircase wave.

Total count (denoted as N) will divide the amplitude to N-1 of step. When N is odd number, the step rising is (N-1)/2, the step falling is (N-1)/2+1; when N is even number, the step rising is N/2, the step falling is (N/2).

The time interval (maximum 9999.9) represents the duration of each step. The time interval and the total count determines the wave period.

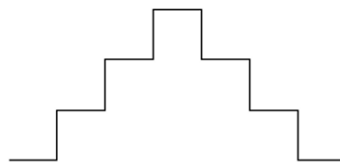

Staircase Wave

7. Exponential Rising Wave

The maximum (denoted as M) and the minimum (denoted as N) of the wave determines the amplitude of the wave.

The total count (denoted as P) and the time interval (maximum 9999.9) determines the wave period.

The rise index (denoted as R) is the independent variable of the rise function, which is set as an integer from 0 to 10 in this system to determine how fast or slow the waveform rises, and the base is Euler's number (e= 2.718281828);

The function of the exponential rising wave is defined as:

$$f(x) = (M - N)(1 - e^{-\frac{xR}{P}})$$

(x is the independent variable and can be taken as an integer from 0 to P-1.)

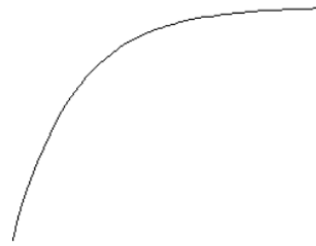

Exponential Rising Wave

8. Exponential Falling Wave

The maximum (denoted as M) and the minimum (denoted as N) of the wave determines the amplitude of the wave.

The total count (denoted as P) and the time interval (maximum 9999.9) determines the wave period.

The fall index (denoted as R) is the independent variable of the fall function, which is set as an integer from 0 to 10 in this system to determine how fast or slow the waveform falls, and the base is Euler's number ($e=2.718281828$);

The function of the exponential falling wave is defined as:

$$f(x) = (M - N)e^{-\frac{xR}{P}}$$

(x is the independent variable and can be taken as an integer from 0 to P-1.)

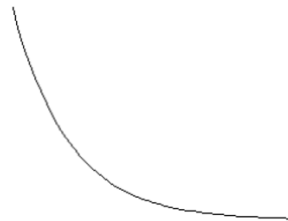

Exponential Falling Wave

3.11.2 Delayer Settings

1. Press the list key  on the panel multiple times to enter Delayer page;
2. Click on the basic setting to set the start point, count, times and stop state. The maximum sum of the start point and the count is 512.
The cycle count can set to 1 to 99999 or "Inf";
Stop: set the condition of voltage, current and power. The delayer will stop when meets the condition.
3. Click on the Edit button to set the parameter of each point or it can set by Template in batches;
4. After the parameter is set, click on the Start button to operating the delayer;
The delayer will stop when meets the condition or it can stop manually, and the delayer will set the power output according to the stop state of the user-defined.

- Click on the Manage button to select the file to save or input the filename and save to the specified storager;

Note: Delayer data is not saved automatically and needs to be saved manually.

Stopped		No	State	delayT(s)
Current	000	509	OFF	1.0
Looped	000	510	OFF	1.0
Start	000	511	OFF	1.0
Groups	512	0	OFF	1.0
Cycles	Inf	1	OFF	1.0
Stop	NONE	2	OFF	1.0
EndState	OFF	3	OFF	1.0
		4	OFF	1.0

Option Edit Start Manage Template

Delayer Page

Template Settings

Press Template to enter the following page.

Stopped		No	State	delayT(s)
Current				1.0
Looped				1.0
Start				1.0
Groups				1.0
Cycles				1.0
Stop				1.0
EndState	OFF	4	OFF	1.0

Type Start Groups Generate Code

- Click on the Edit Object button or rotate the encoder knob to switch to the template of the delayer;
- Click on the Start Point button to numbering the start point;
- Click on the Total Point button to set the number of point that required by the delayer of this time; (the maximum sum of the start point and the total point is 512);
- State code is used to set the template state;
- Duration template is used to set the time change;
 - Fixed duration represents the switch time of the template is fixed;
 - Duration increment/decrement represents each point in the template will step change according to the settings.
- After the above settings is finished, click on the Generate button to complete the delay template output settings.

Template: this product provides four delayer templates, user can select it according to the application fields.

1. State Code

"0" represents the output is off; 1 represents the output is on;

The "01 code" mode indicates that start from the start point is the closed state, until the total points are all set to follow the cycle state of "01";

The "10 code" mode indicates that start from the start point is the opened state, until the total points are all set to follow the cycle state of "10";

PS: This template only changes the output state of the point.

2. Fixed Duration

Fixed duration is used to open/close the fixed open time (maximum 9999.9s) and the close time (maximum 9999.9s).

"Open time" T_{on} represents that when the output is turned on, the delayer extends the set time and then turns to the closed state.

"Close time" T_{off} represents that when the output is turned off, the delayer extends the set time and then turns to the opened state.

After custom time mode generates the group data, it defaults to the off output state as the starting state.

PS: This template only changes time of the point.

3. Duration Increment

Duration increment is a mode that extends the control output channel to the open or close state by increasing the step value ($T_{step} < 9999.9s$) based on T_{base} .

Calculation formula: $T(i+1) = T(i) + T_{step}$, $T(0) = T_{base}$

PS: This template only changes time of the point.

4. Duration Decrement

Duration decrement is a mode that extends the control output channel to the open or close state by decreasing the step value ($T_{step} < 9999.9s$) based on T_{base} .

Calculation formula: $T(i+1) = T(i) - T_{step}$, $T(0) = T_{base}$

PS: This template only changes time of the point.

Storage and Read

After the parameter of the list output and delayer is set by manual or by template settings, the user can use the storage function to save the parameters in the system or external media for later use.

Storage

This device can separately save 10 group setting values of the three functions of the list output, delayer and state file, and can also save to the external storager.

Press the Menu key on the panel, and click on the "User Group" button to enter the storage interface.

The storage interface includes the set value of each channel voltage and current, over voltage and over current.

No	Device	FileName
0	FLASH	group1.user
1	FLASH	group2.user
2	FLASH	group3.user
3	FLASH	group4.user
4	FLASH	group5.user
5	FLASH	group6.user
6	FLASH	group7.user
7	FLASH	group8.user

Storage Interface of User Group (Note: the file suffix is .user)

After enter the list output function, click on the "Manage" button to save or read the list output data.

No	Device	FileName
0	FLASH	Demo.lst.csv
1	USB	Test.lst.csv

Storage Interface of List Output (Note: the file suffix is .lst.csv)

After enter the delayer function, click on the "Manage" button to save or read the delayer data

No	Device	FileName
0	FLASH	Demo.dly.csv
1	USB	Test.dly.csv

Storage Interface of Delayer (Note: the file suffix is .dly.csv)

Press the encoder knob on the panel, rotate the encoder knob to select and rename the file for later use. After the file is saved, the suffix of the list output file will be .lst.csv, the suffix of the delayer file will be .dly.csv. User can also choose an external storage (such as USB) to save the file.

Read

Open the list output/delayer function, click on the Storage button to enter the storage interface as shown in the following figure; and press the encoder knob on the panel to select and load the parameter group file; press "Read", "The file is loaded successfully" will be prompted.

Continuously press the "ESC" key on the panel two times to go back to the initial page of the list output/delayer; press the "Start" button to complete reading and using the stored files.



Read Interface of List Output File

3.12 Main Menu

The main menu includes the following contents

- Monitor
- Output Settings
- System Settings
- User Group
- Language Settings

3.12.1 Monitor

Monitor function can monitor the output voltage, current, power and digital voltmeter, and alarm the output of each channel according to the set conditions and whether to turn off the output.

Working mechanism

When the monitor determines that the readback voltage, current, power and digital voltmeter is greater or less than the set value, then according to the combination of "AND", "OR" of the current, voltage and power to control the output, and can be set to alarm and prompt.



Output Preset Interface

Operation Steps

1. Press the power switch to turn on the instrument.
2. Open the monitor interface and press the Menu key on the panel or press the encoder knob to enter the monitor interface.
3. Select the channel to be monitored and set the parameters, and then connect the load.
Set the monitor condition: voltage, current, power and digital voltmeter (DVM).
Set the logical relationship: or "I", and "&".
Set the sensitivity of judgment: a monitor event will be generated when the judgment condition is continuously valid for a period of time.
Monitor settings: whether to turn off the output, whether to pop up the prompt box, and whether to turn on the beeper.
4. Turn on the monitor function
Click on the Start button to turn on the function.

3.12.2 Output Settings

Set the operating mode, power-on output and slope.

UDP6900 series provides three slope modes, normal, the slope of voltage (VSR) and the slope of current (ISR).

PS: In the mode of list output, delayer and external analog control, the slope mode is normal.

Normal mode: the voltage and current value will change with the set value.

VSR: the initial current value is the set value, the voltage value will change to the set voltage according to the step.

ISR: the initial current value is the set value, the current value will change to the set current according to the step.

This section is to introduce how to set the slope mode of power and its slope, the setting interface as follows.



Output Settings Interface

Operation Steps

1. Press the power switch to power up the instrument, press the Menu key to enter the menu page, and press Output Settings or rotate the encoder knob to select Output Settings and push the encoder knob to enter the output setting page.
2. Press the Slope Mode button to switch to normal, CV slope or CC slope.
3. Press the Slope Setting button to select the slope in different mode.
4. Normal mode: the slope parameter cannot be set.
5. CV slope mode: set the rising and falling slope of voltage.
6. CC slope mode: set the rising and falling slope of current.
7. The slope parameter can be set by the encoder knob and the numerical keyboard.

UDP6900 series provides three power operation modes.

Normal mode: the output voltage and current is set by manual or remote command.

External analog control (Ext-V): the voltage and current setting values change according to the voltage values V_s and I_s input from the rear interface.

External digital control (Ext-D): the voltage, current, OVP and OCP are automatically loaded into the corresponding preset parameters 0~7 based on the external digital inputs D0, D1 and D2, which form the digital quantity 0~7. Please refer to section 3.15.3 for parameter explanation.

Operation Steps of Power Mode

1. Press the power switch to power up the instrument, and press the Menu key to enter the menu page, and then press Output Settings button or rotate the encoder knob to select the Output Settings and push the encoder knob to enter the output settings page.
2. Click on the Operating Mode button, and rotate the encoder knob and push the encoder knob multiple times to switch to different operating mode.

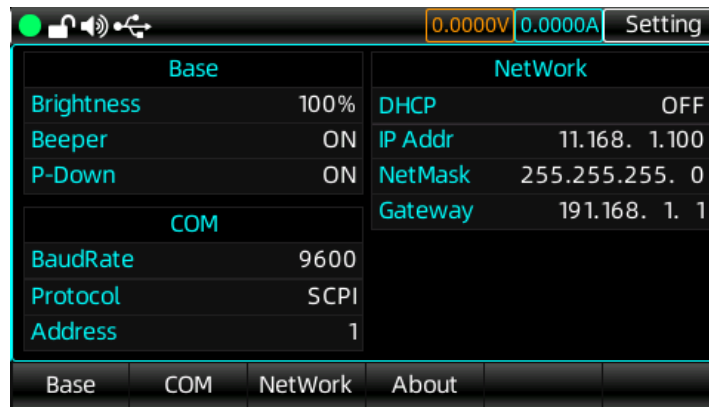

3.12.3 System Settings

System settings include backlight, sound, RS232, network and communication settings. You can also check the information of this machine.





System Settings Interface

Enter System Settings

Press the Menu key  slightly to enter the main menu, and use the encoder knob  to move to the system settings, and then push the encoder knob  one time to enter the system settings page.



Another way is to press the button  under "System Settings" in the main menu interface to enter the system settings interface.

Backlight Brightness Setting

Enter the basic setting, press the button  slightly under "Brightness" to locate to the brightness setting, and rotate the encoder knob  to adjust the brightness. Press the ESC  key slightly to exit the backlight brightness setting after the setting is finished.



Note: The range of backlight brightness is 20-100%.

Beeper Setting



Enter the basic setting, press the button  slightly under "Sound" to locate to the sound setting, and rotate the encoder knob  to turn on/off the beeper. The key sound will be triggered when the sound is enabled; the system will be muted when the sound is disabled. Press the ESC  key slightly to exit the sound setting after the setting is finished.

Brown-out Detection

The output will be turned off and discharge, and alarms when AC is brown-out.

Enter the basic setting, press the button  slightly under "Brown-out Detection" to locate to the brown-out detection setting, and rotate the encoder knob  to turn on/off the brown-out detection. Press the ESC  key slightly to exit the brown-out detection setting after the setting is finished.

Baud Rate Setting

Enter the basic setting, press the button  slightly under "Baud Rate" to locate to the baud rate setting, and rotate the encoder knob  or use the numerical keyboard to set the baud rate.

Note: The setting range of baud rate is 9600~115200.

Communication Protocol and Address

- (1) UDP6900 series includes the communication protocol of SPCI, Modbus and Multi-SCPI Modbus.
- (2) The specified protocol refer to Modbus programming manual and SCPI programming manual.
- (3) Enter the "Communication Settings" under the "System Settings" interface, click on the "Communication Protocol" button and rotate the encoder knob to switch and select a protocol.
- (4) The communication address can set to 1~32. Address 0 is used to broadcast (only valid in the protocol of Multi-SCPI and Modbus).
- (5) Click on the ESC key to exit the parameter settings.

Network Settings



Network Settings Interface

Enter the system settings interface after the above operation is set, press the button  slightly under "Network Settings" to locate to the network settings, and use the numerical keyboard to input the parameter and press the save key.

Notes

- i. The network settings won't take effect immediately after setting. It will be effected after press the Save key and prompt "The storage is successful."
- ii. When DHCP displays on, the network address and other parameters are not editable. And the DHCP will be refresh updated when the address is assigned.

View Device Information and Restore to Factory Settings

Enter the system settings interface after the above operation is set, press the button  slightly under "About Device" to view the device information.

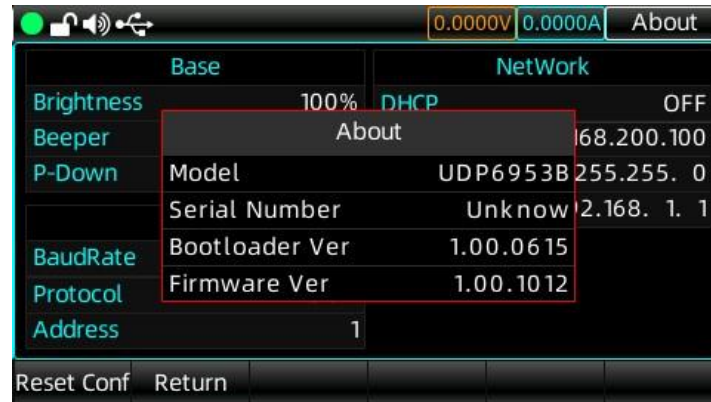



Device Information

3.13 User Group

Load/store the output settings and preset values of the user group. 3.7 subsection has introduced the storage operation of preset group in detail, after the storage operation of preset group is completed, entering the user group settings, then rotate the encoder knob to select a group, press the button under "Save", and then press the button under "Load" to modify the name. Press the button under "Save", then press the button under "Load", and press the "Rename" button to change the name. When load the group, entering the user group interface, select the stored group by rotating the encoder knob, and press "Load" to recall.

3.14 Language Setting

Press the "Menu" key  slightly to enter the main menu, and rotate the encoder knob to locate to the language setting, and step rotate the encoder knob  to switch to English/Simplified-Chinses. The instrument only supports the two languages English/Simplified-Chinses at present. Press the ESC  key slightly to exit the system settings after the setting is finished.



Language Setting

3.15 Terminal Function on Rear Panel

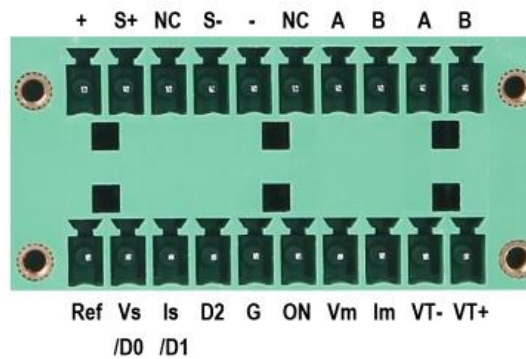

Terminal Figure on Rear Panel

Definition of Rear Panel Interface	
+	Power output +
S+	Remote line loss compensation +
S-	Remote line loss compensation -
-	Power output -
G	Power output GND
Ref	10V regulated power supply output, it is generally used for external analog control (Ext-V).
Vs/D0	External analog control: Voltage analog quantity (0~10V) is corresponding to 0~VoutMax.
Is/D1	External analog control: Current analog quantity (0~10V) is corresponding to 0~IoutMax.
D2	External analog control
ON	External digital/analog control: power output control, high level; open the output; low level; close the output
Vm	Voltage output the analog output channel (0~10V) is corresponding to 0~VoutMax.

Im	Current output the analog output channel (0~10V) is corresponding to 0~IoutMax.
VT-	Digital voltmeter channel, input range: 0~VoutMax
VT+	
NC	Not connected
A	RS485 interface A RS485 interface B RS485 interface B
B	RS485 interface B

3.15.1 Voltage Measurement Function

UDP6900 series has built-in 4 1/2 voltmeter function. The terminal inputs on the rear panel of the instrument allow to measure the DC voltages from 0.001V to 65.000V (UDP6933B/53B can measure the DC voltage up to 160.0V), and the measured values **0.000V** can be seen at the top of the home page.

Notes

1. Correctly connect the terminal V+, V- .
2. The maximum measurement voltage of UDP6900 series is 65V (the maximum measurement voltage of UDP6933B/53B is 160.0V). If a voltage is high than the limit value, it may cause damage to the instrument.
3. Voltmeter function measures DC only, do not use for AC measurement.
4. This function is turned on and off in the "Voltmeter Settings" in the "Output Settings" in the "Menu".

3.15.2 Remote Measurement Function

Remote measurement can measure the output voltage at the device to be tested, a feature that allows compensation for voltage drops on wires between the power supply's front panel terminals and the device to be tested, improving test accuracy.

Operation Steps

1. Use two wires to connect S+ to the positive terminal of the device under test and S- to the negative terminal of the device to be tested.
2. Connect a pair of drive leads from the rear panel + and - terminals to the device to be tested.

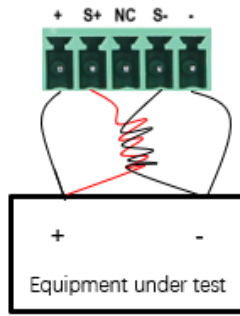

Left Figure



Right Figure

Notes:

1. To ensure the stability of the system, please use armored twisted pair cable between the remote measurement of UDP6900 and the load. Please pay attention to the positive and negative polarity when connecting the cable, otherwise the instrument will be damaged!
2. The left figure "+" and the right figure "-" are the auxiliary output terminals, the current shall not be greater than 3A, if you need to output high current, please connect the high current output terminal on the right figure.

3.15.3 External Analog Quantity

All UDP6900 series has external analog function. There is an external analog interface on the rear panel of the power supply, it can control the output voltage, current and switching output by inputting an external voltage (0~10 V), and output monitor by outputting 0~10 V through Vm and Im. If the user connects a voltage control device to multiple power supplies, the outputs of multiple power supplies can be adjusted at the same time.

To control or monitor the output of the power supply through an external analog signal. The external analog control and external digital control interfaces are defined as follows.

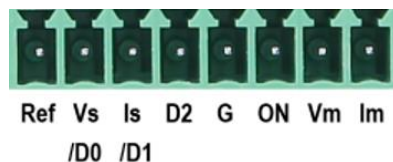

External digital control: D0, D1 and D2 consist of digital quantities 0~7 which correspond to the 0~7 groups of Preset values.

Terminal of external analog quantity: REF_10V Vs/D0 Is/D1 D2 ON/OFF Vm Im NULL GND which correspond to the reference voltage, voltage control/digital quantity D0, current control/digital quantity D1, digital quantity D2, turn on the output and close the control, voltage monitor and current monitor.

How to use the external analog control interface

You can use three channels of 0~10V analog signals to control the output on/off of the voltage, current and power respectively; Vm and Im channels output 0~10V analog signals to monitor the voltage and current output of the power supply respectively.

Terminal explanation as show in in the following table.

	Normal Mode	External Analog Control Ext-V	External Digital Control Ext-D
Ref	10V Regulated Voltage Output		
Vs/D0	Null	Voltage analog control (0~10V)	Digital input D0
Is/D1	Null	Current analog control (0~10V)	Digital input D1
D2	Null	Null	Digital input t D2
ON	Null	Power output the external control, high: turn on the output; low: turn off the output	
Vm	Voltage monitor analog quantity output (0~10V)		
Im	Current monitor analog quantity output 出(0~10V)		

Connecting Example of External Analog Control Hardware

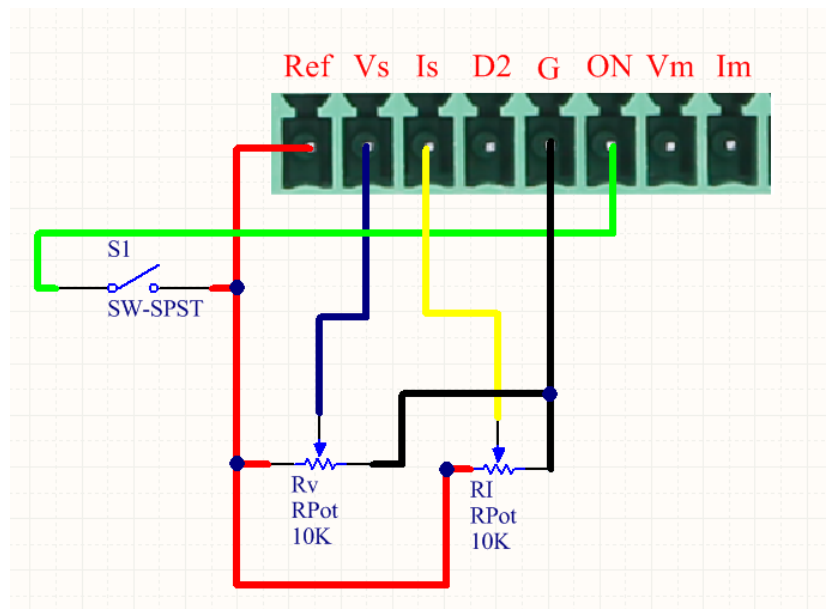

- (1) As shown in the above figure, entering the output settings to set the operating mode to the external analog control Ext-V.
- (2) Slide to Rv or RI to set the value of voltage or current.
- (3) Close S1 to turn on the output.

3.15.4 RS232 and RS485

RS232 DB9 and RS485 are using the same serial port.

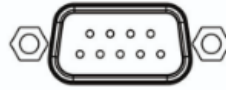

RS232 Interface

RS485 interface (refer to the figure of 3.15 Terminal Function on Rear Panel). It can connect to RS485 interface of other master controller via a cable.



RS485 Interface

Before communication, please check whether the serial port settings and local address (only valid under Multi-SCPI and Modbus protocol) are correct.

Baud rate: 9600, 14400, 19200, 38400, 57600, 115200

Parity check and data bits: no parity check, 8 bits of data bits, 1 bit of stop bit

Communication Settings

- (1) Enter the menu settings.
- (2) "System Settings" → "Communication Settings", adjust the baud rate, communication protocol and address.
- (3) Multi-machine connection settings: Select communication protocol (SCPI, Multi-SCPI, Modbus) in "System Settings".

SCPI only supports master-slave point-to-point communication, while Multi-SCPI and Modbus support multi-slave communication (different addresses need to be set).

Note: Please refer to "SCPI Programming Manual" for SCPI and Multi-SCPI protocols, and "Modbus Programming Manual" for Modbus protocol.

Multi-machine Communication Hardware Connection Diagram Based on RS485

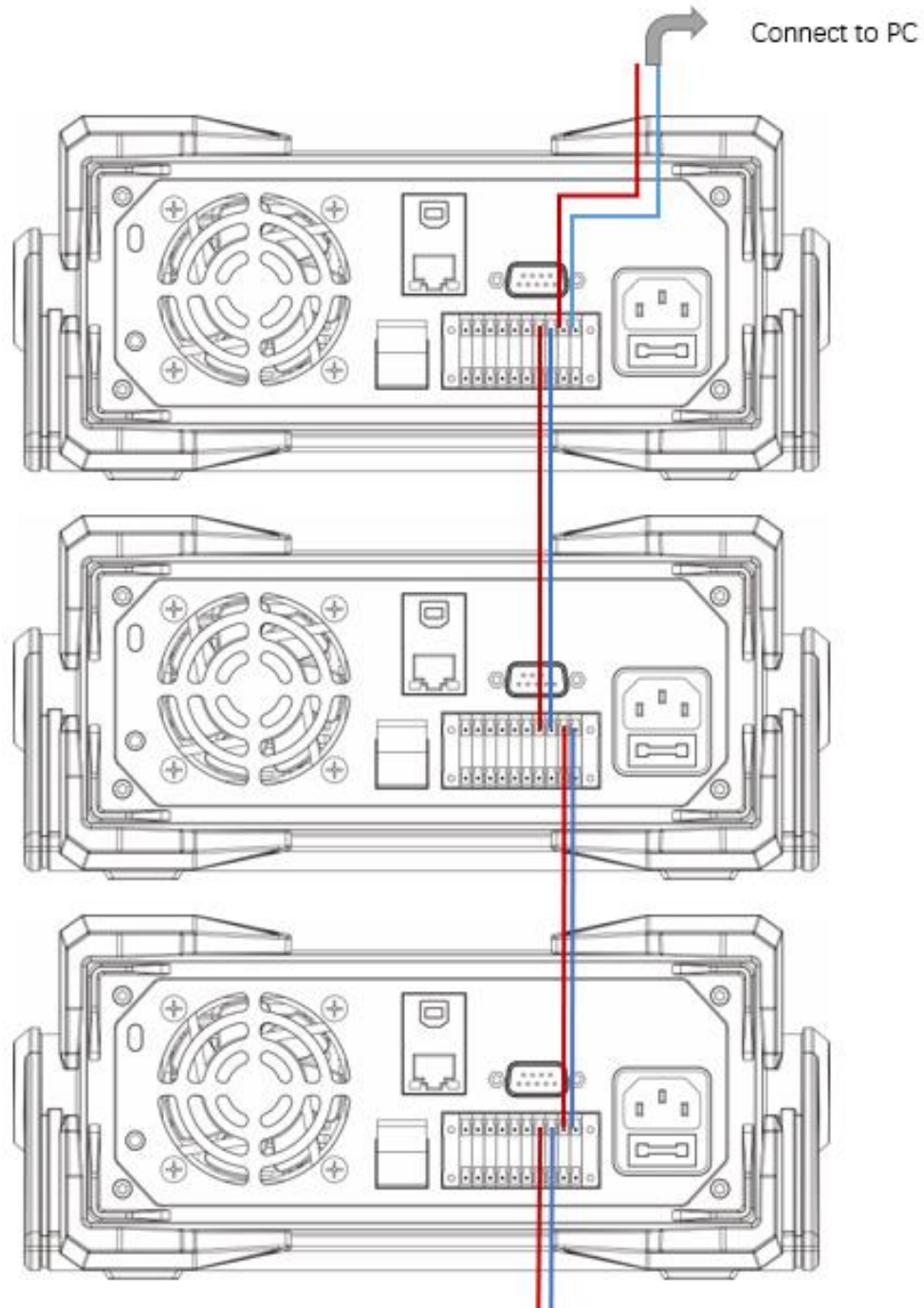

Note: USB to RS485 module is required to connect to a PC.

4. Remote Control

4.1 Upper Computer Control

Remote Operation Steps

1. Download the "Instrument Application" installation file from the website of UNI-T (www.uni-trend.com);
2. Turn on the power;
3. Connect the RS232 or USB or LAN control cable between PC and UDP6900 series power supply;
4. Start the remote control application program;
5. Taking UDP6942B as an example, click on the "Instrument Application", select the connection method, and then double-click the UDP6942B power supply icon to enter the remote communication interface.

The operation diagram is as follows.

1. Click on the Scan button to pop out the selection box;
2. Select the port type;
3. Double-click the device icon to enter the remote operation page;
4. Click on the Start button to make connection;
5. Set the list output and the delay;
6. The top V represents the voltage display; A represents the current display; P represents the power display; the bottom V represents DVM display;
7. Operating the mode settings;
8. Over-voltage and over-current settings;
9. Turn on/off the output.

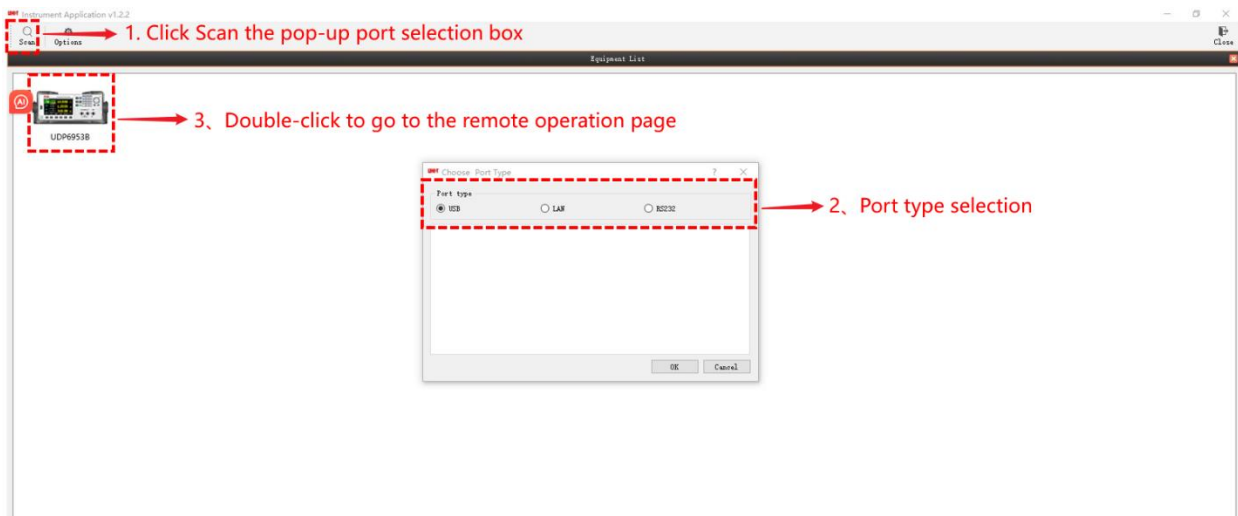

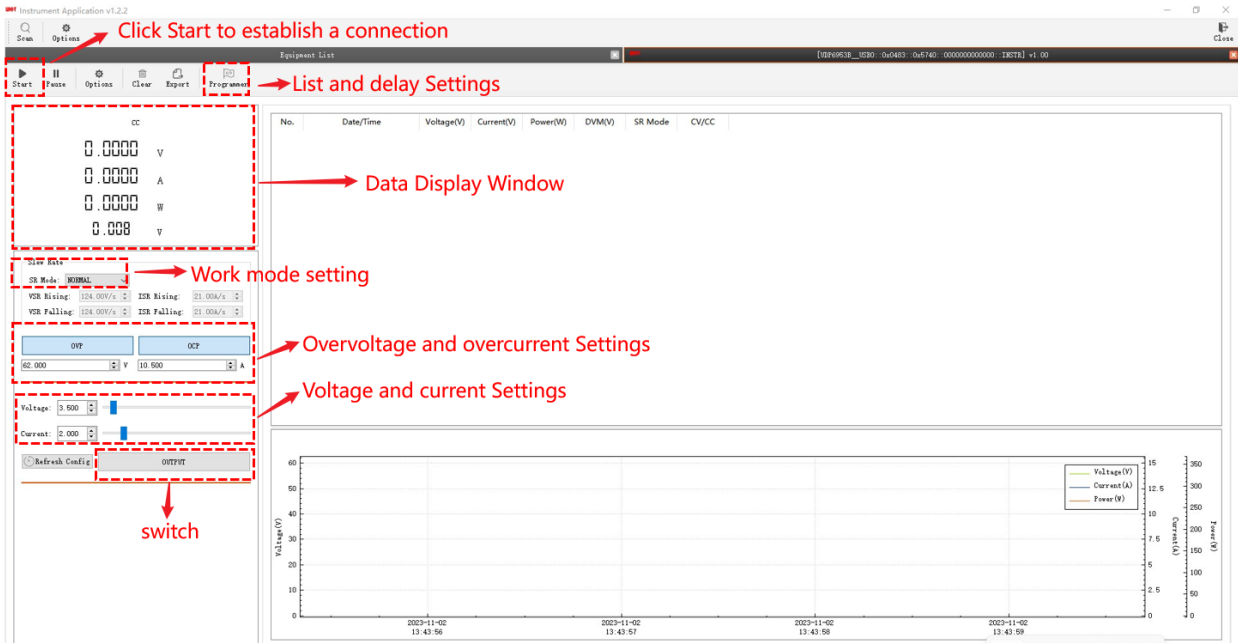

4.2 Web Control

UDP6900 series supports web remote control.

1. Connect the LAN port of UDP6900 power supply to the router and connect to the network, the status bar of the power supply indicates the icon  that the LAN port has been successfully connected;
2. Click on the "Menu" key of UDP6900 power supply to enter "System Settings" and "Network Settings"; Note: When DHCP is turned on, it will automatically obtain IP address and update IP address and other parameters (requires the router to support DHCP service).
3. Open the PC computer browser, enter the IP address on the power supply, such as 192.168.100.100;
4. After Web is connected, UDP6900 power supply will enter the remote control mode, the key will be automatically locked (only "On/Off" is valid), long press the "Lock" key to exit the remote control mode.
5. Page explanation.

(1) Main Page

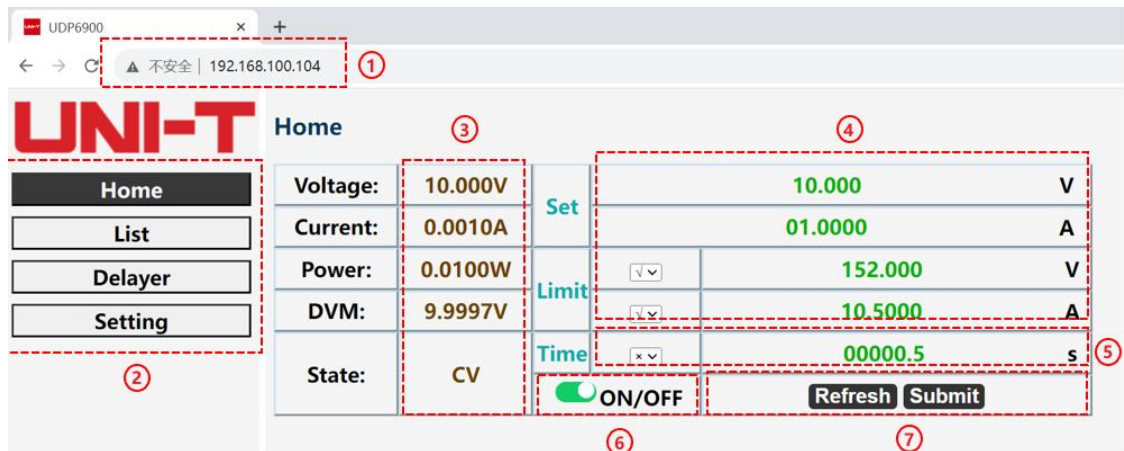

- ① Web page address, i.e., IP address of the power.
- ② Navigation page

- ③ The current output status of power supply (periodic refresh)
- ④ Power output settings
- ⑤ Timer shutdown settings
- ⑥ Power output switch
- ⑦ Refresh and submit the setting parameters

(2) List Output Mode

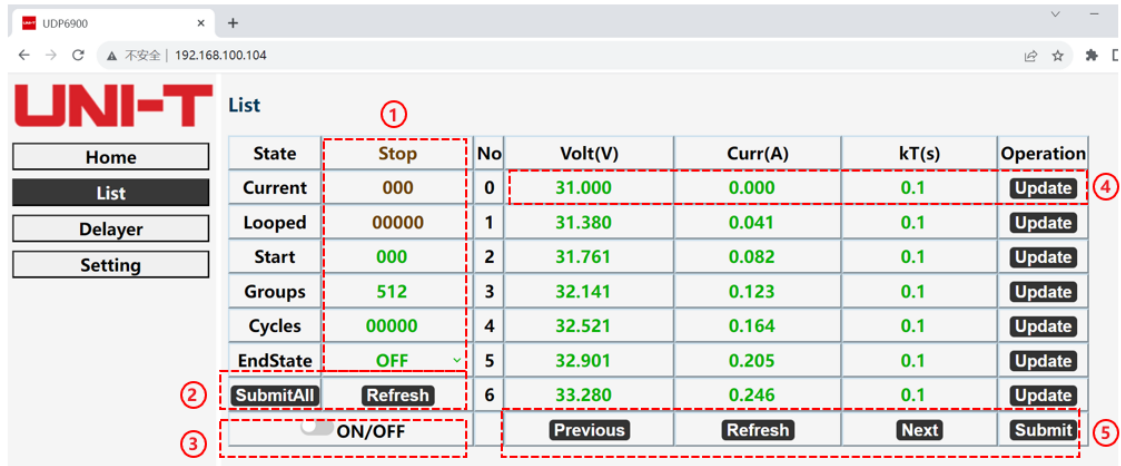

- ① List outputs the current parameters (periodic refresh) and user-defined parameters.
- ② Submit the settings and refresh the setting parameters
- ③ Turn on/off List function
- ④ Set and submit the group parameter settings
- ⑤ Page up/down, refresh group parameter, and submit group parameter in batch.

(3) Delayer

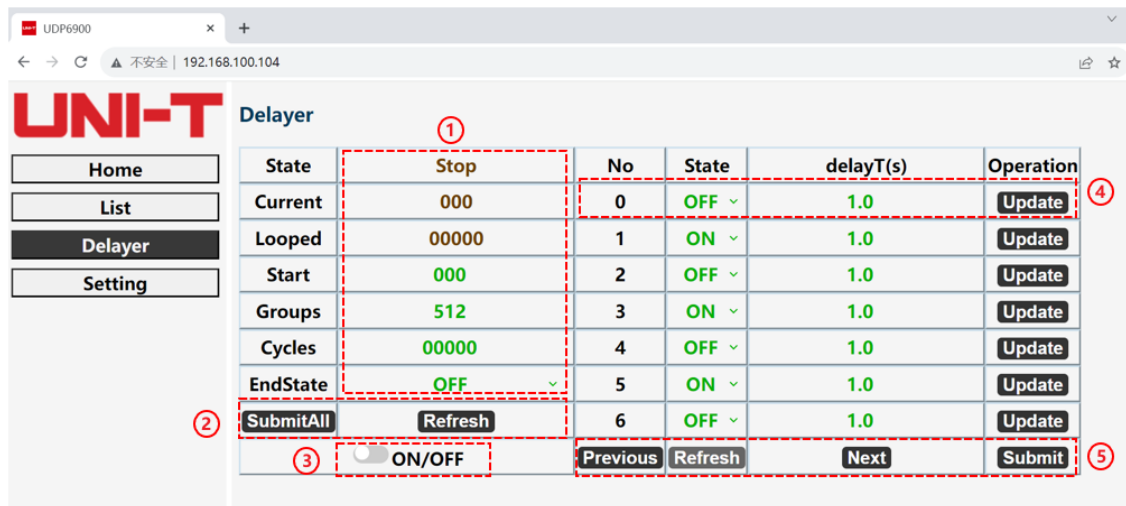

- ① The delayer outputs the current parameters (periodic refresh) and user-defined parameters.
- ② Submit the settings and refresh the setting parameters
- ③ Turn on/off Delayer function
- ④ Set and submit the group parameter setting
- ⑤ Page up/down, refresh group parameter, and submit group parameter in batch.

(4) System Settings

UNI-T

Setting

Brightness	100	%	Submit
Beeper	ON	▼	Submit
P-Down	ON	▼	Submit
BaudRate	9600	▼	Submit
Protocol	SCPI	▼	Submit
Address	1		Submit
DHCP	OFF	▼	Submit
IP Addr	192.168.100.104		Submit
NetMask	255.255.255.0		Submit
Gateway	192.168.100.1		Submit
Refresh			SubmitAll

5. Technical Index

Parameter		UDP6922B	UDP6932B	UDP6942B
Rated Value (0°C~40°C)	Voltage	0~60V	0~60V	0~60V
	Current	0~5A	0~10A	0~15A
	Power	100W	200W	360W
Load Regulation ±(%of output+offset)	Voltage	≤0.01%+3mV	≤0.01%+10mV	≤0.01%+30mV
	Current	≤0.05%+2mA	≤0.05%+4mA	≤0.05%+6mA
Power regulation ratio ±(%of output+offset)	Voltage	≤0.01%+3mV	≤0.01%+10mV	≤0.01%+30mV
	Current	≤0.05%+2mA	≤0.05%+4mA	≤0.05%+6mA
Setting Resolution	Voltage	1mV	1mV	1mV
	Current	0.1mA	0.1mA	0.1mA
Readback Resolution	Voltage	0.1mV(<10V)	0.1mV(<10V)	0.1mV(<10V)
		1mV(>10V)	1mV(>10V)	1mV(>10V)
	Current	0.1mA	0.1mA	0.1mA(<10A) 1mA(>10A)
Setting Accuracy (25°C±5°C) ±(%of output+offset)	Voltage	≤0.03%+5mV	≤0.03%+5mV	≤0.03%+5mV
	Current	≤0.1%+5mA	≤0.1%+10mA	≤0.1%+15mA
Readback accuracy (25°C±5°C) ±(%of output+offset)	Voltage	≤0.03%+5mV	≤0.03%+5mV	≤0.03%+5mV
	Current	≤0.1%+5mA	≤0.1%+10mA	≤0.1%+15mA
Ripple (20Hz ~20MHz)	Voltage	≤5mVp-p	≤8mVp-p	≤15mVp-p
	Current	≤5mA _{rms}	≤6mA _{rms}	≤8mA _{rms}
SENSE voltage (V)	1V			
Size (mm)	215mmW×88mH×373.7mmD			
Gross weight	4.0 KG			

Parameter		UDP6933B
Rated Value (0 °C~40 °C)	Voltage	0-150V
	Current	0-5A
	Power	200W
Load Regulation ±(% of output+offset)	Voltage	≤0.01%+20mV
	Current	≤0.01%+6mA
Power regulation ratio ±(% of output+offset)	Voltage	≤0.01%+20mV
	Current	≤0.01%+6mA
Setting Resolution	Voltage	1mV
	Current	0.1mA
Readback Resolution	Voltage	1mV(<100V), 10mV(≥100V)
	Current	0.1mA
Setting Accuracy (25°C±5°C) ±(% of output+offset)	Voltage	≤0.04%+30mV
	Current	≤0.1%+10mA
Readback accuracy (25°C±5°C) ±(% of output+offset)	Voltage	≤0.04%+30mV
	Current	≤0.1%+10mA
Ripple	Voltage	≤30mVp-p
	Current	≤6mArms
SENSE voltage(V)	1V	
Size	215mmW×88mH×373.7mmD	
Gross weight	4.0 KG	

Parameter		UDP6952B	UDP6953B
Rated Value (0°C~40°C)	Voltage	0~60V	0~150V
	Current	0~25A	0~10A
	Power	600W	600W
Load Regulation ±(% of output+offset)	Voltage	≤0.01%+30mV	≤0.01%+25mV
	Current	≤0.1%+10mA	≤0.05%+10mA
Power regulation ratio ±(% of output+offset)	Voltage	≤0.01%+30mV	≤0.01%+25mV
	Current	≤0.1%+10mA	≤0.05%+10mA
Setting Resolution	Voltage	1mV	1mV
	Current	0.1mA	0.1mA
Readback Resolution	Voltage	0.1mV(<10V) 1mV(>10V)	1mV(<100V) 10mV(>100V)
	Current	0.1mA(<10A)	0.1mA

		1mA(>10A)	
Setting Accuracy (25°C±5°C) ±(%of output+offset)	Voltage	≤0.03%+5mV	≤0.03%+20mV
	Current	≤0.1%+25mA	≤0.1%+25mA
Readback accuracy (25°C±5°C) ±(%of output+offset)	Voltage	≤0.03%+5mV	≤0.03%+20mV
	Current	≤0.1%+25mA	≤0.1%+25mA
Ripple (20Hz ~20MHz)	Voltage	≤20mVp-p	≤50mVp-p
	Current	≤15mArms	≤15mArms
SENSE voltage (V)	1V		
Size	215mmW×88mmH×373.7mmD		
Gross weight	4.5 KG		

UNI-TREND TECHNOLOGY (CHINA) CO., LTD.

No.6, Industrial North 1st Road, Songshan Lake Park, Dongguan City, Guangdong Province, China

Postal Code: 523 808

www.uni-trend.com