

P/N:110401111770X

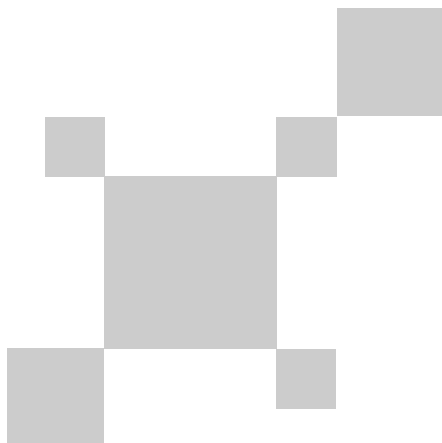

UNI-T

UNI-TREND TECHNOLOGY (CHINA) CO., LTD.

No.6, Gong Ye Bei 1st Road,
Songshan Lake National High-Tech Industrial
Development Zone, Dongguan City,
Guangdong Province, China

UNI-T[®]

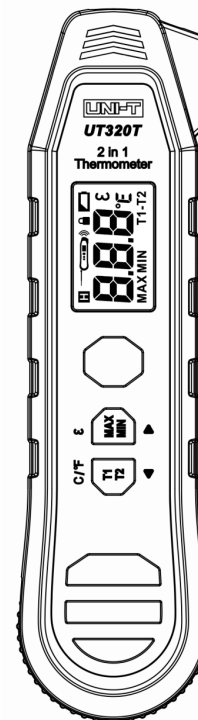

UT320T

2 in 1 Thermometer User Manual

PREFACE

Thank you for purchasing the new UT320T thermometer. In order to use this product safely and correctly, please read this manual thoroughly, especially the Safety Instructions part.

After reading this manual, it is recommended to keep the manual at an easily accessible place, preferably close to the device, for future reference.

LIMITED WARRANTY AND LIABILITY

UNI-T guarantees that the product is free from any defect in material and workmanship within one year from the purchase date. This warranty does not apply to damages caused by accident, negligence, misuse, modification, contamination and improper handling. The dealer shall not be entitled to give any other warranty on behalf of UNI-T. If you need warranty service within the warranty period, please contact your seller directly.

This warranty is the only compensation you can obtain. UNI-T will not be responsible for any special, indirect, incidental or subsequent damage or loss caused by any reason or speculation. As some areas or countries do not allow limitations on implied warranties and incidental or subsequent damage, the above limitation of liability and stipulation may not apply to you.

ABOUT

Due to different batches, the materials and details of actual products may be slightly different from the graphic information. Please refer to the goods received. The experimental data in the manual are theoretical values and all from UNI-T's internal laboratories, for reference only. Customers cannot use them as bases for placing orders. If users have any questions, please contact customer service.

TABLE OF CONTENTS

1. Overview	4
2. Safety Instructions	4
3. Product Structure	5
4. Screen Indicators/Icons	6
5. Specifications	7
6. Operation	9
7. Infrared Measurement	11
8. Maintenance and Cleaning	13
9. Troubleshooting	14
10. Notice for Use	14

1. Overview

UT320T ("Thermometer "or" Product ") is a thermometer that combines infrared and probe measurements. Infrared measurement is used to quickly scan the surface temperature of an object by measuring the infrared energy radiated by the target surface. Probe measurement can accurately measure the internal temperature of objects.

2. Safety Instructions

⚠ Warning:

In order to prevent eye damage or personal injury, please read the following safety instructions before using the product:

- Do not point the laser directly at persons or animals or indirectly through reflective surfaces.
- Do not look directly at the laser or with optical tools (binoculars, microscopes, etc.).



- When the probe is unfolded, do not point it to persons or animals.

Cautions:

- If the laser irradiates the user's eyes, please close the eyes immediately and turn the head away.
- Do not disassemble or refit the product and laser without permission.
- To ensure its safety and accuracy, this product should only be repaired by professional maintenance personnel using original replacement parts.
- Replace the batteries when the low battery indicator shows to prevent incorrect measurements.
- Please check the product before using it. If it is damaged, cracked on the surface or missing plastic parts, do not use it.
- In the infrared measurement mode, highly reflective objects or transparent materials will make the actual temperature higher than the measured temperature. When measuring these objects, pay attention to the risk of burns.
- Do not use the product in an environment with flammable and explosive liquid, gas or dust.
- Do not use the product around the environment with steam, dust, or large temperature fluctuations if it is in the infrared measurement mode. It may bring inaccurate results and risks.
- Put the product in the current environment for more than 30 minutes before using it to ensure infrared measurement accuracy.
- Do not leave the thermometer on or near objects of high temperature.

- Do not make the plastic housing contact with high temperature objects to prevent plastic deformation and melting.
- In the probe mode, do not insert the probe into the measured object for a long time. Take out the probe after 1 minute of measurement, and then measure after the product returns to normal temperature.
- Do not place the product in a dishwasher, oven, microwave, or soak in any liquid.

3. Product Structure

- ① Infrared sensor
- ② Single laser
- ③ LCD
- ④ Scan | Hold

- Press it to turn on the thermometer in the infrared mode or wake up the thermometer in the probe mode.

- In the infrared mode: Press it to measure. Release it to hold the data.

- In the probe mode: Switch measurement state (auto measurement/hold)

⑤ Max/Min | ε

- Short press (less than 0.5s): View the maximum or minimum value

- Long press (about 1.5s): Enable the emissivity setting function

⑥ T1/T2 | °C/°F

- Short press (less than 0.5s): Enable the temperature difference calculation function

- Long press (about 1.5s): Temperature unit conversion (°C/°F)

⑦ Probe

⑧ Probe dial

⑨ Battery cover screw

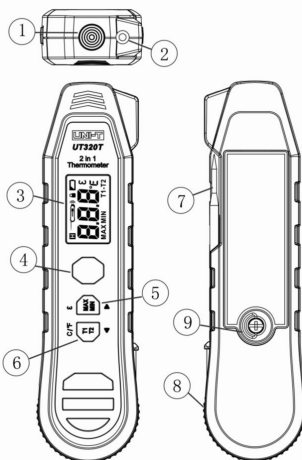

4. Screen Indicators/Icons



	Data hold
	Lock measurement
	Emissivity
	Value display
	Temperature difference
	Infrared/Probe measurement
	Low battery
	Temperature units (°F/°C)
	Maximum/minimum temperature

5. Specifications

Model	UT320T		
LCD size	18*28mm		
LCD type	FSTN		
Infrared measurement	Measuring range	-40°C~300°C (-40°F~572°F)	
	Temperature	Range	Accuracy
		-40°C≤t≤0°C:	±(2.0+0.1× t)°C
		0°C t≤300°C:	±2.0°C or ±0.02×t°C whichever is greater
		-40°F≤t≤32°F:	±(4.0+0.1× t-32)°F
		32°F t≤572°F:	±4.0°F or ±0.02×t°F whichever is greater
	Temperature coefficient	±0.1°C/°C or ±0.1%/°C whichever is greater	
	Distance to spot ratio (D: S)	8 : 1	
	Emissivity	Adjustable (0.1~1.0)	
	Spectral range	5μm~14μm	
	Response time	≤500ms (95% of reading)	
	Repeatability	1.0°C or 1.0% whichever is greater (2.0°F or 1.0% whichever is greater)	
	Laser	Class 2, single laser, power 1mW, wavelength 650±20nm	
	Operating time	About 30h (laser and backlight on)	
Probe measurement	Measuring range	-40°C~300°C (-40°F~572°F)	
	Accuracy	Range	Accuracy
		-40°C≤t 0°C:	±2.0°C
		0°C t≤300°C:	±1.0°C or ±0.01×t°C whichever is greater
		-40°F≤t≤32°F:	±4.0°F
		32°F t≤572°F:	±2.0°F or ±0.01×t°F whichever is greater

Probe measurement	Probe type	NTC		
	Minimum measuring depth	12.7mm		
	Operating time	About 180h (backlight on)		
Over range display	Measured value	maximum range: display "OL"	Measured value	minimum range: display "-OL"
Operating temperature	0°C~50°C(32°F~122°F)			
Storage temperature	-20°C~60°C(-4°F~140°F)			
Operating humidity	<90%Rh (non-condensing)			
Highest operating altitude	2000m			
IP rating	IP54			
Drop test	2m			
Battery type	2 * 1.5V AAA			
Auto power off time	10min			
Data hold	√			
Lock measurement	√			
Unit conversion (°C/°F)	√			
Max/Min/Difference	√			
Certificates	Probe FDA certification	Conform to FDA standards		
	Laser safety standards	IEC 60825-1:2014; EN 50689:2021		
	CE	EMC: EN 61326-1:2021; Safety: EN 61010-1:2010+A1:2019+AC:2019		
	UKCA	Based on CE certification standards		
	RoHS	Refer to RoHS Directive 2011/65/EU Directive (EU) 2015/863		
Product weight	About 110g (with batteries)			
Product size	155*42*22.5mm			

6. Operation

6.1 Replace Batteries

When using the product for the first time, please install the batteries first.

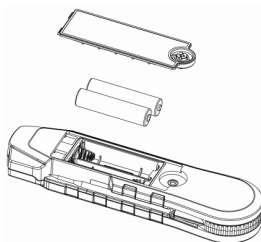

To remove the battery cover:

- Hold the metal ring on the screw with a hand or a tool, and turn the ring counterclockwise to unscrew the battery cover screw.
- Use a screwdriver to unscrew the battery cover.
Battery type: 2 AAA alkaline batteries

Note:

- Pay attention to the battery polarity when installing.
- After replacing the batteries, close the battery cover and tighten the screw.

6.2 Power On/Off

- When the probe is folded, press the Scan|Hold button to turn on the thermometer and enter the infrared (non-contact) mode.
- When the probe is unfolded, it will enter the probe (contact) mode and the thermometer will be turned off when the probe is folded (not in the T1/T2 mode).
- When the thermometer is turned on, the backlight will automatically turn off if no button press occurs for nine minutes, and then the product will automatically shut down if still no button press occurs for one minute.
- When the probe is unfolded, after the product shuts down automatically, press the Scan|Hold button to wake it up.
- In the T1/T2 mode, the temperature difference can be calculated. If the probe is unfolded in the T1/T2 mode, fold the probe to switch to the infrared mode, and the thermometer will not be turned off. If users want to fold the probe to turn off the thermometer, please exit the T1/T2 mode first.

6.3 Temperature Measurement

Infrared mode:



Press the Scan|Hold button to measure the temperature, and release it to stop measuring. The top left corner of the LCD displays , and the data is held.

Probe mode:

When the probe is unfolded, the product automatically starts measuring. Insert the probe at least 12.7mm into the measured object, and wait for the value to stabilize before reading the temperature. Press the Scan|Hold button. The top left corner of the LCD displays , and the data is held. Press the Scan|Hold button again to return to the auto measurement.

6.4 Function Settings

Lock measurement in the infrared mode:

- When the measured data is held in the infrared mode, press the Scan|Hold button twice,  will show in the upper right corner of the LCD and the thermometer will enter the lock measurement mode. The measurement can be performed without pressing any buttons at this time.
- In the lock measurement mode, press the Scan|Hold button to exit the lock measurement, and the icon  will disappear

Max/Min:

- When the measured data is held, press the Max/Min|ε button to step through the Max, Min (the last continuous measurement) and exit viewing the Max/Min.
- If the temperature is measured when the Max/Min function is enabled, the Max and Min of the current continuous measurement are displayed

Emissivity adjustment:

- Long press the Max/Min|ε button to enter the emissivity setting interface.
- In the setting interface, press the Up/Down button to adjust the value. Short press once to add or subtract 0.01. Long press to add or subtract 0.1 per second.
- After the emissivity is set, press the Scan|Hold button to save the emissivity and return to the measurement interface.
- This function can only be enabled in the infrared mode.

Temperature difference:

After the thermometer is turned on for measurement, short press the T1/T2 | °C/°F button to step through T1>T2>T1-T2>T1. When T1-T2 is displayed, press the Scan|Hold button to exit the T1/T2 mode (or long press the T1/T2 | °C/°F button to exit in any state of the T1/T2 mode).

Temperature units:

Long press the T1/T2 | °C/°F button to step through temperature units °C/°F.

7. Infrared Measurement

7.1 D: S (Distance to Spot Ratio)

As the distance (D) between the thermometer and the measured target increases, the light spot diameter (S) of the measured area also increases. The relationship between measurement distance and light spot diameter is shown in the figure below.

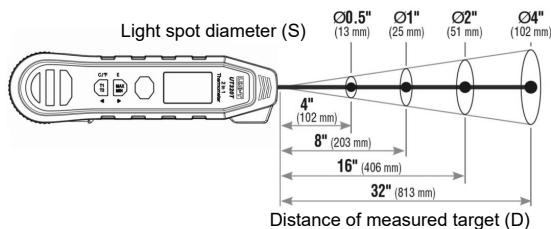

**The light spot diameter represents
95% of the energy in the circle**

7.2 Field of View

When measuring, make sure that the measured target is larger than the light spot diameter (S). The smaller the target, the closer the test distance should be (refer to D: S for the detailed light spot diameter). It is recommended that the measured target be larger than twice the light spot diameter of the thermometer.

7.3 Emissivity

Emissivity represents the ability of the measured object to emit infrared energy. Infrared measurement is to measure the infrared energy to determine the temperature.

Objects of different materials have different emissivity. The emissivity of most organic materials, painted or oxidized surfaces is about 0.95. The user can use masking tapes or flat paints to cover the metal surface, and then wait for a period of time to make the surface temperatures of the tapes/flat paints and the covered object the same. At this point, the surface temperature of the tapes/flat paints is equal to the metal surface temperature.

The following table shows the total emissivity ϵ of some metals and non-metals.

Measured surface	Emissivity
Metals	
Aluminum Oxide	0.2-0.4
A3003 Alloy Oxide Crude	0.3 0.1-0.3
Brass Polishing Oxide	0.3 0.5
Cuprum Oxide Electrical terminal board	0.4-0.8 0.6
Hastelloy Alloy	0.3-0.8
Inconel Oxide Abrasive blasting Electropolishing	0.7-0.95 0.3-0.6 0.15
Ferrum Oxide Rusting	0.5-0.9 0.5-0.7
Ferrum (casting) Oxide Non-Oxide Casting	0.6-0.95 0.2 0.2-0.3
Ferrum (forging) Passivating	0.9
Plumbum Crude Oxide	0.4 0.2-0.6
Molybdenum Oxide	0.2-0.6
Nickel Oxide	0.2-0.5
Platinum Black	0.9

Steel	
Cold rolling	0.7-0.9
Burnishing	0.4-0.6
Polishing	0.1
Zinc	
Oxide	0.1
Non-Metals	
Asbestos	0.95
Asphalt	0.95
Basalt	0.7
Carbon	
Non-Oxide	0.8-0.9
Graphite	0.7-0.8
Carborundum	0.9
Ceramic	0.95
Clay	0.95
Concrete	0.95
Cloth	0.9
Glass	
Convex glass	0.76-0.8
Smooth glass	0.92-0.94
Nonex	0.78-0.82
Sheet material	0.96
Gypsum	0.8-0.95
Ice	0.98
Limestone	0.98
Paper	0.95
Plastic	0.95
Water	0.93
Soil	0.9-0.98
Wood	0.9-0.95

8. Maintenance and Cleaning

- The ingress protection rating of UT320T thermometer is IP54. The housing and probe can be cleaned with a moist sponge or soft cloth. Please dry the product after cleaning.
- Use a cotton swab soaked in water or medical alcohol to clean the surface of the lens.

9. Troubleshooting

Phenomenon	Cause	Measure
Display OL	Measured value maximum range	Stop measuring
Display -OL	Measured value minimum range	Stop measuring
Display Err (startup)	Exceed the minimum/maximum operating temperature or infrared sensor damage	Place the thermometer at 0°C-50°C (32°F-122°F) for 30 minutes. If Err is still displayed, the product needs to be repaired.
Battery symbol flashes	Low battery	Replace batteries
Display Er0 (startup)	Internal damage	Restart the product or reinstall the batteries and then restart it. If the product still does not operate normally, repair it.
Inaccurate infrared measurement	Too far measurement distance, diameter of the measurement target 12mm	Refer to Field of View, D: S and other instructions in this manual.
Inaccurate probe measurement	Probe damage, insert the probe less than 12.7mm into the measured object	Repair the probe if it is damaged.

10. Notice for Use

Infrared measurement:

- If the ambient temperature changes (e.g., from indoor to outdoor), the thermometer should be allowed at least 30 minutes to stabilize, otherwise error may be caused.
- If there is dust or foreign matter on the lens of the infrared sensor, clean the lens according to the method (8. Maintenance and Cleaning) and continue to measure after the lens surface is dry.
- Make sure there are no other obstacles between the product and the measured object.

Probe measurement:

- The probe has a minimum penetration depth of 12.7mm.
- Do not use the product in corrosive acids or alkalis.