

UT309A/UT309C Professional Infrared Thermometer User Manual

Overview

UT309 series professional non-contact infrared thermometer can determine surface temperature through measuring infrared energy radiated by the target surface.

Safety Instructions

Warning:

- To avoid eyes or personal injury, please read the following safety instructions before using this product:
- Please do not irradiate people or animals with laser directly or indirectly.
- Please do not look at the laser directly or through other optical tools (telescope, microscope, etc).
- Before using the product, if battery symbol on LCD display is flashing, replace batteries at immediately to avoid inaccurate measurements.
- Before using the product, check the product for damages. If the surface has cracks or lacks rubber parts, do not use the product.
- Please refer to the radiation coefficient (emissivity chart at the end of the manual) to get the actual temperature. Reflective objects will cause the measured value to be lower than the actual temperature value. When measuring these objects, please be aware not to touch high temperature surfaces.
- Do not use this product in explosive gas and steam environment.
- To ensure measurement accuracy, place this product in test environment temperature for more than 30 minutes before using it.
- Avoid keeping the thermometer near high temperature objects for a long time.

Specifications

Functions	UT309A	UT309C
Measurement Range	-35°C~450°C (-31°F~842°F)	-35°C~650°C (-31°F~1202°F)
Accuracy	≥0°C: ±1.8°C or ±1.8% of reading, whichever greater. <0°C: ±(1.8°C+0.1°C/°C) ≥32°F: ±3.6°F or ±1.8% of reading, whichever greater. <32°F: ±(3.6°F+0.1°F/°F)	
Calibration Temperature Range	21°C~25°C (70°F~77°F)	
Temperature Coefficient	0.1°C/°C (0.1°F/°F) or ±0.1% of reading per degree, whichever greater	
D:S Ratio	10:1 (calculated when energy is 90%)	12:1 (calculated when energy is 90%)
Emissivity	0.95	0.1~1.0 adjustable
Response Time	250ms (95% of reading)	
Spectral Response	8um~14um	
Display Resolution	0.1°C (0.1°F)	
Repeatability	±1.0°C (1.8°F) or 0.8% of reading, whichever greater.	
Laser Quantity	Single Laser	Dual Laser
Laser Type	CLASS II	
Laser Wavelength	630nm~670nm	
Laser Power	<1mW	
Battery Type	9V Battery (6F22)	
Battery Life	≥12h (Work continuously with backlight on)	≥10h (Work continuously with backlight on)
Product Size	189mm*118mm*55mm	
Weight	292g	
Operating Temperature	0°C~50°C (32°F~104°F)	
Storage Temperature	-20°C~60°C (-4°F~140°F)	
Operating Humidity	<90% RH (non-condensing)	
Operating Altitude	2000m	
Storage Altitude	12000m	
Protection Level	According to IEC60529, complies with IP65	
Drop Test	3m	

Safety Standards

CE Identification: EN61326: 2013 EN61326-2-2: 2013
Laser Safety Standard: EN60825-1: 1994+A2: 2001+A1: 2002

Product Features

- Strong and Durable:** Passed 3m drop test
- Dustproof and Waterproof:** Passed IP65 level dustproof and waterproof tests.
- Ergonomic Design:** Comfortable handheld, simple and convenient operation.
- MAX/AVG/DIF/MIN:** Can quickly display the maximum, minimum, average and difference value (between maximum and minimum) during measurement.
- Large Backlight Screen:** Large screen, bold fonts, and uniform white backlight combined makes it an attractive display.
- Alarm Function:** High and low temperature alarm is displayed with flashing LED and screen, to easily observe measurement results when alarm is triggered.
- Dual Laser:** UT309C uses dual wavelength laser indication to enhance measurement area accuracy.

Function Description

	Temperature Measurement Lock Trigger	
	Laser ON	
HI LO	High and Low Limit Alarm	
	Low Battery	
SCAN	Temperature Measurement Trigger	
HOLD	Measurement Data Hold	
°F/°C	Unit	
8888	Measurement Value on Main Display	
MAX MIN AVG DIF	Mode	
ε = 0.88	Emissivity	
8888	Measurement Value on Secondary Display	

Operations

Power On and Off

- Gently pull the trigger to power on thermometer, LCD screen and white backlight will be on.
- The thermometer will power off automatically without operation in 8s.

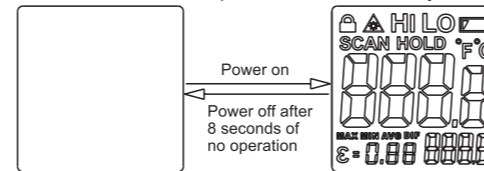

Manual Measurement

- Pull and hold the trigger after aiming at the target. SCAN icon will be flashing indicating target object temperature is being measured.
- Release trigger and SCAN icon disappears, HOLD icon appears, indicating measurement has stopped and the last measured value is kept.

Temperature Locking (Trigger Free Measurement)

- During temperature locking, pull trigger to enable function. icon will appear on thermometer screen and SCAN icon flash. Thermometer keep continuous measurement target temperature, and backlight is auto off after 2 minutes.
- Pull trigger again, and SCAN icons will disappear, HOLD icon will appear. Thermometer stop measurement and keeps the last measured value.

Note: During measurement, target must be larger than the light spot to ensure accuracy. Please refer to the D:S values.

MAX/MIN/AVG/DIF Value Reading

Short press MODE button to change MAX/MIN/AVG/DIF modes respectively, temperature value of corresponding modes are shown in the secondary display area.

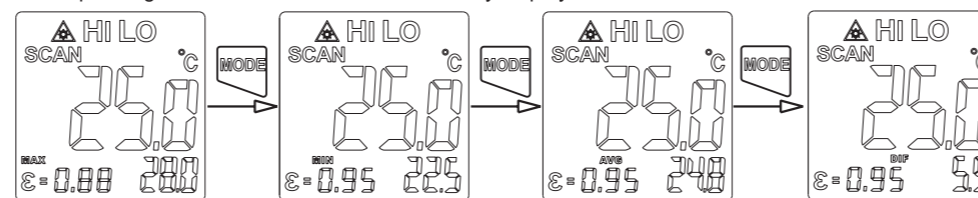

HIGH Alarm Limit Setup

Short press SET button to enter HIGH alarm limit setup (as shown below), use up and down buttons to set values. Short press up or down buttons to add or subtract 1, long press up or down button to add or subtract 10. Device will exit limit setup after 5 seconds without any operation.

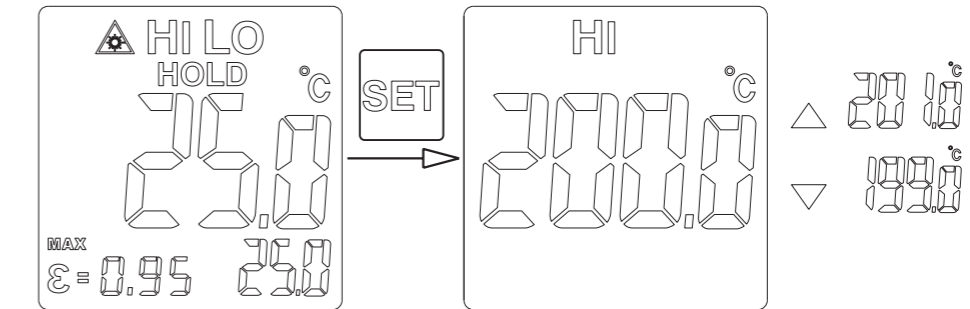

LOW Alarm Limit Rang Setup

Short press SET button to enter LOW alarm limit setup. Please use HIGH alarm setup procedure to setup LOW alarm.

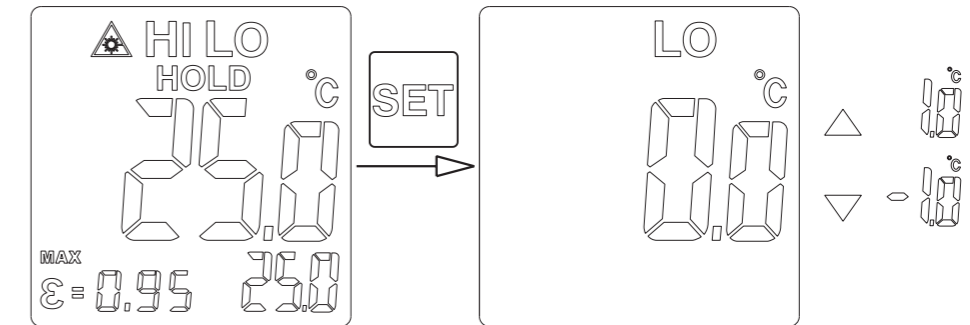

Emissivity Setup

UT309C emissivity can be adjusted from 0.01 to 1.0. Short press SET button to enter emissivity setup interface (as shown below). Use up and down function buttons to set values. Short press up button or down button to add or subtract 0.01 unit, long press up button or down button to add or subtract 0.1. Thermometer will exit setup after 5 seconds of no operation.

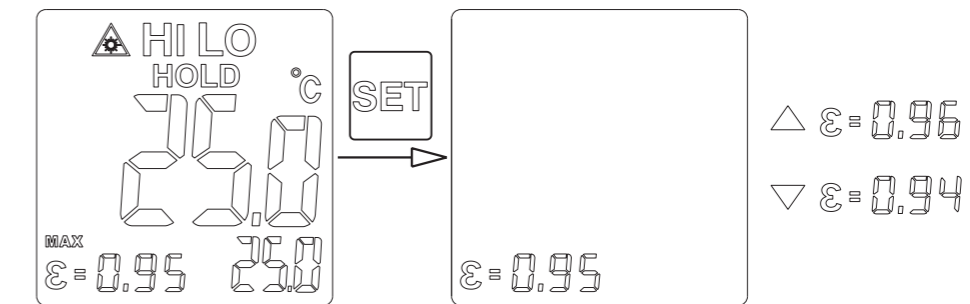

Unit Setup

Short press SET button to enter unit setup interface (as shown in the following figure), use up and down function buttons to change °C and °F units. Thermometer will exit setup after 5 seconds of no operation.

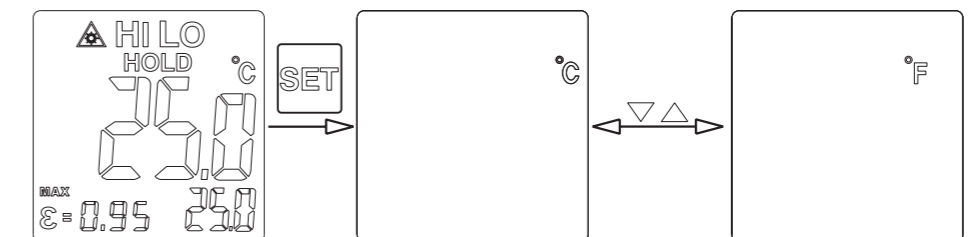

Laser on or off Setup

Short press SET button to enter laser on or off setup interface (as shown below), use up and down function buttons to open or close laser. Thermometer will exit setup after 5 seconds of no operation.

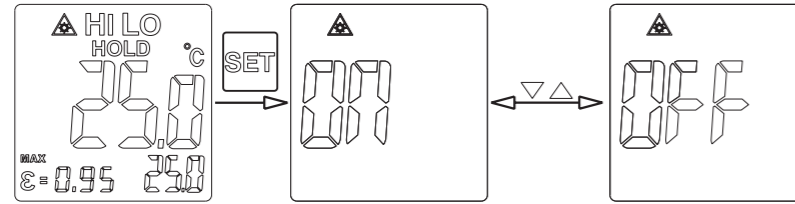

Turn on or off Lock Measurement Setup

Short press SET button to enter open or close lock measurement setup interface (as shown in the following figure), use up and down function buttons to open or close laser. Thermometer will exit setup after 5 seconds of no operation.

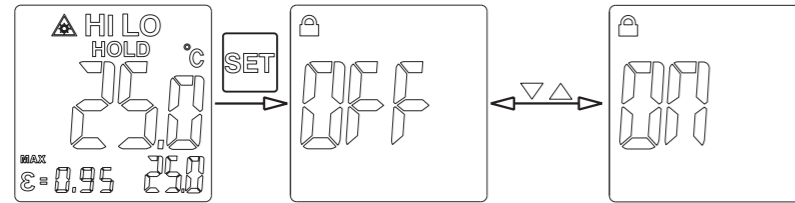

Turn on or off High Limit and Low Limit Alarm Function

Short press HI/LO function button to open or close high limit and low limit alarm function in order. The order is: turn on HI LO limit alarm at the same time → turn off LO limit alarm function → turn off HI limit alarm function → turn off HI LO limit alarm functions → turn on HI LO limit alarm functions at the same time, and the cycle repeats.

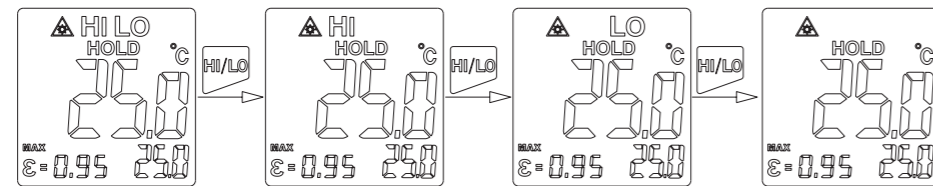

When the alarm function is on, alarm will go off when the temperature goes over the limit value. If measured temperature is higher than HI alarm limit, red LED and display will flash. If measured temperature is lower than LO alarm limit, blue LED and display will flash.

Find Heat Point and Cold Point

Aim at target area with thermometer, then move up and down slowly to sweep the whole area until the heat point and cold point are found.

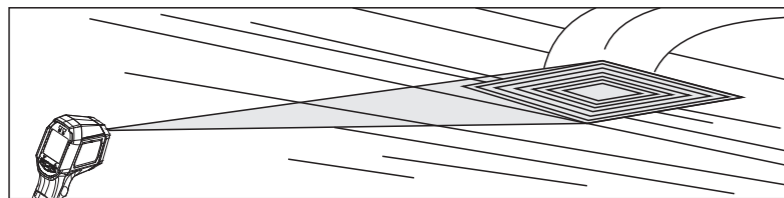

D:S (Distance Coefficient)

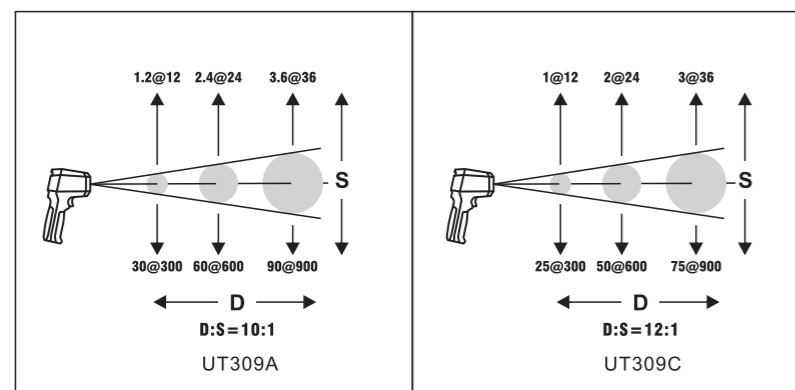

Visual Field

Ensure that the target is larger than light spot. The smaller the target is, the closer is the measurement distance. Suggested measurement distance should be less than 75% of theoretical value.

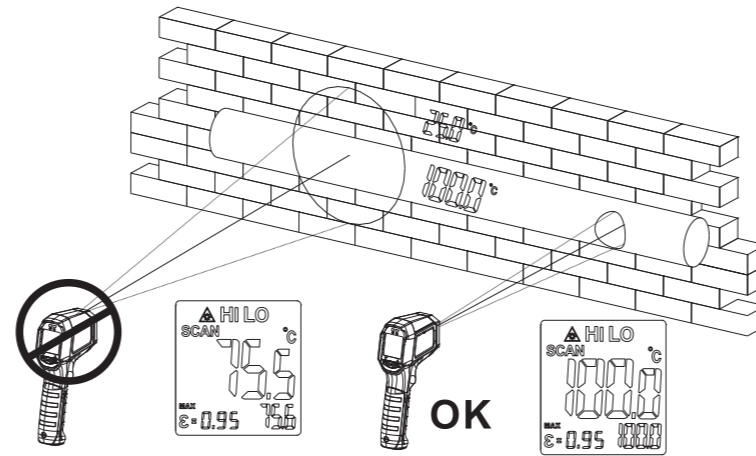

Emissivity

Emissivity characterization reflects the of material's radiated energy. Emissivity for most organic materials, paints or oxidized surfaces are about 0.95. Total emissivity of selected metals and non-metals are listed in the following table.

Measured Surfaces	Emissivity
Metal	
Aluminum	
Oxidization	0.2-0.4
A3003 Alloy	
Oxidization	0.3
Rough	0.1-0.3
Brass	
Burnishing	0.3
Oxidization	0.5
Copper	
Oxidization	0.4-0.8
Electric Terminal Board	0.6
Hastelloy	
Alloy	0.3-0.8
Inconel	
Oxidization	0.7-0.95
Sand-Blasting	0.3-0.6
Electro Burnishing	0.15
Iron	
Oxidization	0.5-0.9
Rusting	0.5-0.7
Iron (Casting)	
Oxidization	0.6-0.95
Non-Oxidization	0.2
Casting	0.2-0.3
Iron (Forging)	
Passivation	0.9
Lead	
Rough	0.4
Oxidization	0.2-0.6
Molybdenum	
Oxidization	0.2-0.6
Nickel	
Oxidization	0.2-0.5
Platinum	
Black	0.9
Steel	
cold rolling	0.7-0.9
Steel Plate Burnishing	0.4-0.6
Steel Plate Rubbing	0.1
Zinc	
Oxidization	0.1

Non-Metal	
asbestos	0.95
asphalt	0.95
basalt	0.7
Carbon	
Non-Oxidization	0.8-0.9
Graphite	0.7-0.8
Silicon Carbide	0.9
ceramics	0.95
Clay	0.95
concrete	0.95
Cloth	0.9
Glass	
Convex Glass	0.76-0.8
Smooth Glass	0.92-0.94
Lead-Boron Glass	0.78-0.82
Plates	0.96
Stone Products	0.93
Plaster	0.8-0.95
Ice	0.98
Limestone	0.98
Paper	0.95
Plastics	0.95
Water	0.93
Soil	0.9-0.98
Wood	0.9-0.95

Maintenance

Clean

Use clean compressed air to blow away falling particles.
Use wet cotton swab to carefully wipe lens surface.
Use wet sponge or soft cloth to clean product exterior.

Battery Replacement

Install or replace 6F22 9V battery according to the following figure.

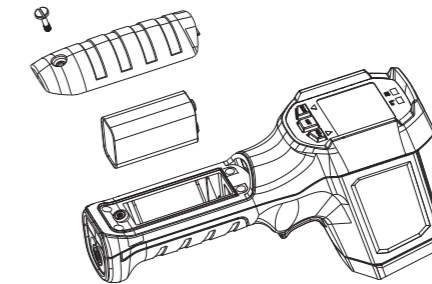

Manufacturer:
Uni-Trend Technology (China) Limited
No 6, Gong Ye Bei 1st Road
Songshan Lake National High-Tech Industrial
Development Zone, Dongguan City
Guangdong Province
China
Postal Code: 523 808

Headquarters:
Uni-Trend Group Limited
Rm901, 9/F, Nanyang Plaza
57 Hung To Road
Kwun Tong
Kowloon, Hong Kong
Tel: (852) 2950 9168
Fax: (852) 2950 9303
<http://www.uni-trend.com>

说明书菲林做货要求:

序号	项目	内容	
1	尺寸	展开尺寸420×280±1MM	折后尺寸(140x140mm)
2	材质	60g书纸	
3	颜色	单色双面印刷	
4	外观要求	完整清晰、版面整洁，无斑墨、残损、毛边、刀线错位等缺陷。	
5	装订方式	无	
6	表面处理	无	
7	其它	无	
版本		REV. 0	
DWH 设计	宣浩	MODEL	Part NO.
CHK 审核		机型: Ut309英文	物料编号: 110401106096X
APPRO. 批准		 优利德科技(中国)有限公司 UNI-TREND TECHNOLOGY (CHINA) LIMITED	