

UT503PV

Photovoltaic Insulation Resistance Tester

User Manual



Preface

Thank you for purchasing this brand new product. In order to use this product safely and correctly, please read this manual thoroughly, especially the Safety Instructions part.

After reading this manual, it is recommended to keep the manual at an easily accessible place, preferably close to the device, for future reference.

Limited Warranty and Liability

Uni-Trend guarantees that the product is free from any defect in material and workmanship within one year from the purchase date. This warranty does not apply to damages caused by accident, negligence, misuse, modification, contamination or improper handling. The dealer shall not be entitled to give any other warranty on behalf of Uni-Trend. If you need warranty service within the warranty period, please contact your seller directly.

Uni-Trend will not be responsible for any special, incidental or subsequent damage or loss caused by using the device.

Contents

1. Overview	4
2. Accessories	5
3. Safety Information	5
4. Electrical Symbols.....	9
5. External Structure	9
6. Button Descriptions	10
7. LCD Display	11
8. Button Functions	12
9. Operating Instructions	14
10. Conventional Connecting methods	26
11. Technical Specifications	29
12. Communication Functions.....	34
13. Maintenance.....	35

1. Overview

UT503PV can be used to measure photovoltaic energized (maximum: 1000V DC) insulation resistance and conventional insulation resistance (de-energized) and automatically identify AC/DC voltage. It has multiple functions including: photovoltaic insulation resistance measurement without solar panel in power outage/short circuit condition or at night, voltage stepping, Bluetooth transmission, automatic discharge, high voltage warning, remote-controlled test lead operation, and more. UT503PV is commonly applied to test insulation resistance for various equipment such as photovoltaic panel, battery energy storage system, new energy vehicles, etc.

1.1 Model

Model	Rated voltage	Insulation resistance range	Short-circuit current
UT503PV	125V, 250V, 500V, 1000V	0.125MΩ~4000MΩ	Less than 1.5mA

1.2 Features

1. Photovoltaic insulation resistance measurement (PV)
2. Conventional insulation resistance measurement
3. AC/DC voltage testing (VDC/VAC)
4. Maximum insulation resistance range: 4000MΩ
5. Rated voltage for conventional output (Conventional insulation resistance: 4 positions): 125V, 250V, 500V, 1000V
6. Rated voltage for PV output (Photovoltaic insulation resistance: 2 positions): 500V, 1000V
7. Short-circuit current: <1.5mA
8. Step of each range: 10% of rated voltage
9. Comparative measurement of insulation resistance (COMP)
10. Time-set measurement of insulation resistance (TIME)
11. External voltage detection function to enable monitoring energized voltage of measured object automatically
12. Designed with timer to record testing time automatically
13. Automatic discharge and high voltage warning
14. Analog bar graph to display the range of insulation resistance testing result
15. Manual/Automatic power off
16. Capable to save 1000 sets of data
17. Data storage/deletion function
18. Data upload function

19. Bluetooth App
20. Manual/Automatic backlight
21. Mute function
22. LCD high-definition segmented display

2. Accessories

Please carefully check if any accessory below is missing or damaged.

1. User manual: 1 pc
2. Download guideline for general file (Language: English): 1 pc
3. Test leads (reddish black leads: 1 pair; remote-controlled test lead: 1 pc): 3 pcs
4. Lantern-tip test probes: 1 pair
5. Red/Black alligator clips: 1 pair
6. MC4 connectors: 1 pair
7. Type-C cable: 1 pc
8. Carrying strap: 1 pc
9. LR6 AA alkaline Batteries: 6 pc

Please contact your local distributor if any accessory is missing or damaged.

3. Safety Information

The Tester is designed, manufactured and calibrated in accordance with IEC 61010 Safety Standard (Safety Requirements of Electronic Products), Double Insulation, CAT III 600V and CAT II 1000Vdc Standards. To avoid electric shock or personal injury, please carefully read the safety information and precautions in the User Manual before first use.

Warning

- Please keep the Safety Information, User Manual and Tester properly for future reference.
- Please follow the safety information and warning affixed at the Tester to ensure safe use. Failure to follow the operating instructions may compromise the protection provided by the Tester.
- Check the Tester and test leads before use. The test lead insulation shall be intact and the test leads shall not be damaged or broken. The damaged test lead must be replaced. The rated voltage, frequency, type and rated current of the test leads must be same with that of the Tester. Use only test leads approved by EN/IEC 61010-031.
- Stop use if bare test lead, damaged casing, abnormal display or other problems occur. If any

accessory is damaged, please stop use and prevent inadvertent use.









- Do not alter the internal wiring of the Tester.
- Do not use or keep the Tester in environments with high temperature and high humidity.
- Never use the Tester in any environment with flammable and explosive substances or strong magnetic field. Spark can cause explosion.
- It is forbidden to the Tester without the cover closed in place, otherwise it will pose a risk of electric shock.
- Please wear insulated gloves corresponding to measurement category.
- Please ensure the user's hands, shoes, clothing, ground, circuits and components are dry.
- Do not press the TEST button if test leads are not connected.
- When the Tester is performing measurement, please do not contact the bare wire, connector, unused input terminal, alligator clip or circuit under testing.
- Use caution when working with voltage over 30V (DC/AC), please grip the test lead behind the finger guard to avoid electric shock.
- Set the Tester at maximum range if the measured range is unknown. The measured signal is not allowed to exceed the specified maximum limit, to prevent electric shock or damage to the Tester.
- Do not apply overrated voltage or current between terminals, or between any terminal and earth ground.
- Please set the rotary switch at correct position. Disconnect the test leads with the measured circuit before turning the rotary switch. It is forbidden to switch over during measurement.
- Before opening the battery cover, please remove the test leads from the Tester and make sure the Tester is powered off.
- Please grip the probe behind the finger protector.
- Disconnect the test leads with the measured circuit after each measurement operation is completed. After current measurement operation is completed, please switch off the power supply before disconnecting the test leads with the measured circuit, especially for measuring in-circuit current.
- In CAT III measurement locations, please ensure the test lead shield is pressed firmly in place to avoid a risk of electric shock. In CAT II measurement locations, the test lead shield can be

removed so as to perform testing on recessed conductors such as wall outlets. Take care not to lose the shields

- If the low battery symbol appears on the LCD, please replace the battery immediately to ensure measurement accuracy
- Please measure the known intrinsic voltage or current of the Tester before use to ensure the Tester functions normally.
- If the product is not used in the way specified by the manufacturer, the protection provided by the product can be compromised
- Please check the batteries before use or replacement. The batteries must be installed according to the correct polarity
- Turn off the power after measurement is completed. If the battery is not used for a long time, please remove it from the Tester to avoid leakage. If battery leakage occurs, please do not use the Tester before the service center performs check on it.
- Battery acid (electrolyte) is high-alkalinity substance and can conduct electricity (There is a risk of acid burn). If battery acid comes into contact with your skin or clothing, please scour with a large amount of water immediately. In case that battery acid enters your eyes accidentally, please scour with a large amount of water immediately and get medical treatment in time.
- Please keep the batteries in places to which children cannot access, to prevent children or pets from swallowing the batteries.
- Do not dismantle or short the batteries or throw them in fire. It is forbidden to charge non-chargeable batteries, otherwise it may pose a risk of explosion.
- Power off the Tester before cleaning or maintenance. Disconnect the connected measured cable or other accessories from the Tester and all measured objects.
- Please do not immerse the Tester into water or other liquids. Intrusion of any liquid to the Tester is not allowed.
- Please wipe the Tester case with damp cloth and mild detergent. Do not use abrasives or solvents.
- The calibration or maintenance must be performed by qualified repair personnel or designated repair department.

- If the Tester is equipped with replaceable fuse, please adhere to the following operating instructions:
 - 1) Power off the Meter before replacing the fuse and disconnect the connected measured cable.
 - 2) Use only fuse with specified type and current rating. Do not use wrong or repaired fuse or connect the fuse block, otherwise it may cause fire.
- Do not exceed the maximum range during measurement.
- Do not measure voltage over 600VAC or 1000VDC.
- Do not perform test in loop with voltage to ground over 1000V.
- When the Tester is performing measurement, please do not contact the bare wire, connector, unused input terminal, or circuit under testing.
- Make sure the metal portion and the test lead are not shorted, otherwise it may cause personal injury.
- Do not touch the measured circuit during or after insulation resistance test, otherwise it may cause electric shock.
- If any dirt or carbide, which can degrade the insulation performance, occurs at the test leads or terminals, please stop test immediately.
- Do not short or connect the test leads during insulation resistance test, as incorrect operation may cause the test to be interrupted or damage the Tester or the measured object. The top end of the test lead will produce electrical discharge when the test lead is shorted or connected, please note that appropriate electrical discharge may deteriorate the product performance.
- Use only the specified test leads, otherwise measurement cannot be performed safely.
- To prevent electrical accident, please switch off the power of the measured circuit before connecting test leads.

4. Electrical Symbols

	High voltage! Risk of electric shock!
	Double insulated
	Direct current (DC)
	Alternating current (AC)
	Grounding
	Caution or warning
	Battery power
	Conform to European Union standards
	Do not place equipment and its accessories in the trash. Please dispose properly according to the local regulation.
CAT II	MEASUREMENT CATEGORY II is applicable to test and measuring circuits connected directly to utilization points (socket outlets or similar points) of the low-voltage MAINS installation.
CAT III	MEASUREMENT CATEGORY III is applicable to test and measuring circuits connected to the distribution part of the building's low-voltage MAINS installation.

5. External Structure

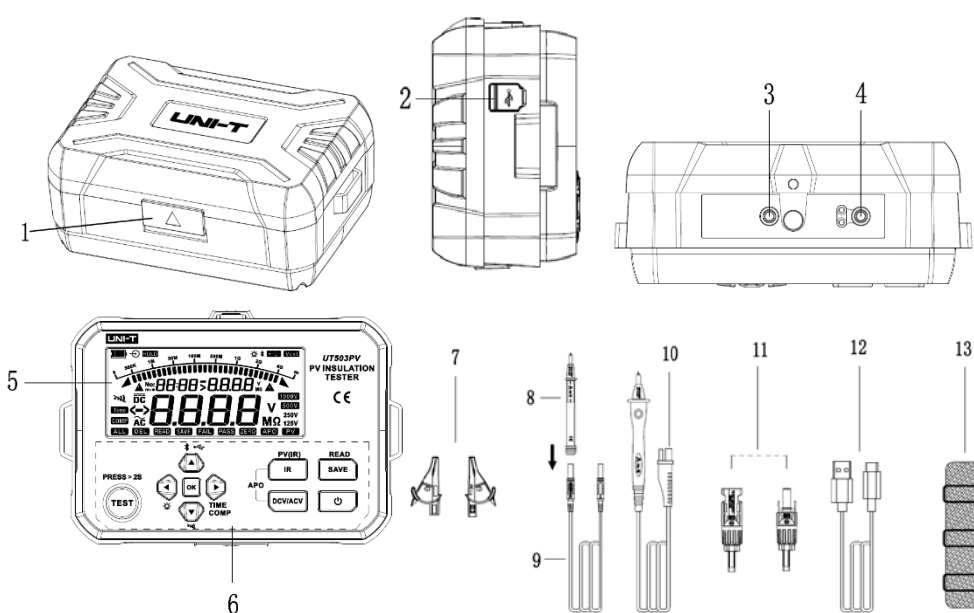

1	Opening of flap cover of protective cover
2	USB: Type-C USB data transmission port
3	EARTH: High resistance measurement terminal (single-ended black lead)
4	LINE: High voltage output terminal (remote-controlled test lead)
5	LCD segmented display
6	Functional buttons
7	Alligator clips
8	Lantern-tip test probe
9	Test lead for high resistance sampling
10	High-voltage remote-controlled test rod (reddish black)
11	MC4 connectors (Male and female)
12	Type-C USB cable
13	Carrying strap

6. Button Descriptions

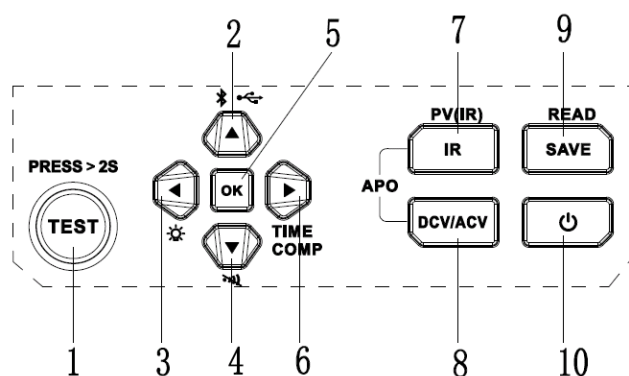

1	Test button
2	Up arrow button
3	Left arrow button
4	Down arrow button
5	OK button (Parameter confirmation)
6	Right arrow button
7	Insulation resistance test button
8	DCV/ACV measurement button
9	Data saving button
10	Power button

7. LCD Display

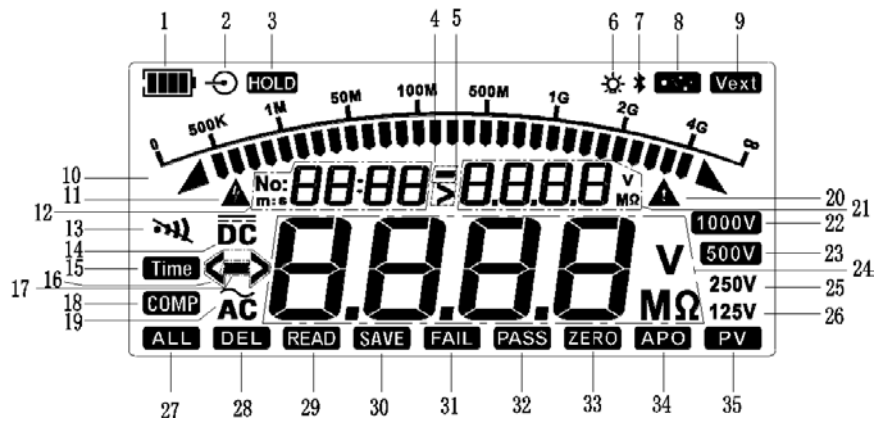

1	Battery power
2	Battery charging(Reverse)
3	Data hold
4	Marking of the direction of terminal voltage in resistance measurement mode
5	Over-range terminal voltage in resistance measurement mode
6	Backlight
7	Bluetooth communication
8	USB communication
9	External energized voltage
10	Analog bar graph for insulation resistance test
11	High voltage warning
12	Display zone for data storage and time
13	Buzzer
14	DV voltage testing mode
15	Time setting
16	Exceed measurement range
17	Reverse input of DC voltage testing
18	Comparative resistance measurement mode; comparative resistance setting
19	AC voltage testing mode
20	Caution or warning
21	Terminal voltage in resistance measurement mode; comparative resistance value setting
22	1000V rated voltage position for insulation resistance test
23	500V rated voltage position for insulation resistance test
24	Measurement result of insulation resistance or AC/DC voltage
25	250V rated voltage position for insulation resistance test
26	125V rated voltage position for insulation resistance test
27	Delete all stored data
28	Delete a single stored data
29	Read the stored data

30	Save data
31	Comparative test of insulation resistance is FAIL
32	Comparative test of insulation resistance is PASS
33	Zero adjustment in low resistance measurement
34	Auto power off
35	Photovoltaic insulation resistance measurement

8. Button Functions

● Power button

Long press this button for >2 sec to power on the Tester (with all segments displayed on the LCD for a second), long press again to power off the Tester. The Tester is designed with auto-off function.

● IR button

This button is used for insulation resistance test, and the default test mode is the continuous testing mode (position: 125V) of conventional insulation resistance. Long press this button to switch to photovoltaic insulation resistance test mode (PV (IR)) and the symbol "PV" appears on the LCD; short press to switch to conventional insulation resistance test mode.

●DCV/ACV button

This button is used for AC/DC voltage measurement. In insulation resistance measurement state, short press this button to switch to AC/DC voltage measurement mode. The Tester can identify AC/DC voltage automatically. Press IR button and DCV/ACV button at the same time to turn on/off the APO function. The APO function is turned on by default after boot-up.

● SAVE button

Short press this button to save the present displayed data. When the number of the saved data shown on the LCD is "No: 1000", the symbol "No: 1000" flashes at a frequency of 1 Hz to indicate that the storage is full and next set of data can be saved until already-saved data is cleared. If new data is to be saved when the already-saved data is not cleared, the first set (original set) of data will be covered by the next set of data by default. The 1000th set of data is the latest set of data.

Long press this button for >2 sec to switch to the "READ" mode (long press this button again to exit the "SAVE" mode or press the main function button to exit the "READ" mode), the displayed data is the latest set of data by default. In "READ" state, long press the Up/Down arrow button to locate certain data fast.

In conventional data reading state, press the left arrow button to select DEL (delete the present set of data), ALL (delete all data) and default "READ" state, then long press OK button to confirm deletion. When ALL is selected, the symbols "ALL", "DEL" and "No:xxxx" will blink at a frequency of 2 Hz, please long press the "OK" button to confirm deletion and return to the default "READ" state. When DEL is selected, the symbol "DEL" will blink at a frequency of 2 Hz, please long press the "OK" button to confirm deletion and return to the default "READ" state.

● Up arrow button (▲)

a. In insulation resistance measurement state or photovoltaic (PV) insulation resistance

measurement state and without high voltage output, press this button to select a higher rated voltage output.

- b. When READ is in operation (that is, when data is read), press this button to select previous set of data.
- c. For time setting, press this button to increase time.
- d. For comparative resistance setting, press this button to increase the resistance.
- e. In a state not for data reading, long press this button to cyclically select the modes below:
 - 1) USB Transmission Mode (the symbol "USB" appears on the LCD). This mode is used with the PC.
 - 2) All USB Data Export Mode (The symbol "USB" on the LCD flashes at a frequency of 2 Hz and then long press the OK button to export all saved data. Return to the conventional USB mode after data export is completed). This mode is used with the PC.
 - 3) Bluetooth Transmission Mode (the Bluetooth symbol appears on the LCD). This mode is used with the APP.
 - 4) Simultaneous Upload (via Bluetooth and USB) Mode. In this mode, the Bluetooth and USB symbols are displayed on the LCD simultaneously. This mode is used with the PC and APP.
 - 5) Default Mode (without data being transmitted).

● Down arrow button (▼)

- a. In insulation resistance measurement state or photovoltaic (PV) insulation resistance measurement state and without high voltage output, press this button to select a lower rated voltage output.
- b. When READ is in operation (that is, when data is read), press this button to select next set of data.
- c. For time setting, press this button to decrease time.
- d. For comparative resistance setting, press this button to decrease the resistance.
- e. Long press this button for >2 sec to turn on/off the buzzer function, that is, the mute mode.

● Left arrow button (◀)

- a. In insulation resistance measurement state or photovoltaic (PV) insulation resistance measurement state and without high voltage output, press this button to decreasingly select the step voltages of the voltage position as step-down output.
- b. For time or resistance setting, this button is used as a cursor button to adjust the digit of time or resistance.
- c. In data reading state, press this button to select DEL (delete the present set of data), ALL (delete all data) and default "READ" state.
- d. Long press this button for >2 sec to turn on/off the backlight function manually. The backlight is turned on by default after boot-up, and it will be turned off after 30 seconds. The backlight can be turned on manually and it will be turned off automatically after 2 minutes of inactivity.

● Right arrow button (▶)

- a. In insulation resistance measurement state or photovoltaic (PV) insulation resistance measurement state and without high voltage output, press this button to increasingly select the step voltages of the voltage position as step-up output.
- b. For time or resistance setting, this button is used as a cursor button to adjust the digit of time or

resistance

c. In insulation resistance measurement mode, long press this button for >2 sec to cyclically select “TIME” mode, “COMP” mode, and continuous mode.

● **OK button**

To adjust parameters in non-measurement state, please short press the OK button to confirm that the setting is valid and to exit the present setting.

Note: Please long press the OK button to confirm deleting the present set of data, deleting all data, and entering the “All USB Data Export Mode”.

● **TEST button**

This button is used to start and stop insulation resistance measurement or photovoltaic (PV) energized insulation resistance measurement. Press this button about 2 seconds to start measurement; short press to exit measurement. The warning light will illuminate the TEST button in red to indicate that the present measurement function is valid.

This button is used as a touch switch for the remote-controlled test rod, long press about 2 seconds to start measurement; short press to stop measurement.

9. Operating Instructions

9.1 Pre-test preparation

(1) Open the protective cover, press the POWER button for > 2 sec to turn on the Tester, the LCD shows all segments for about one second, then the Tester enters the default state. Please check if the Tester can power on normally and if any segment shown on the LCD is missing. If the Tester is faulty, please troubleshoot the problem and ask for help from the technical support.

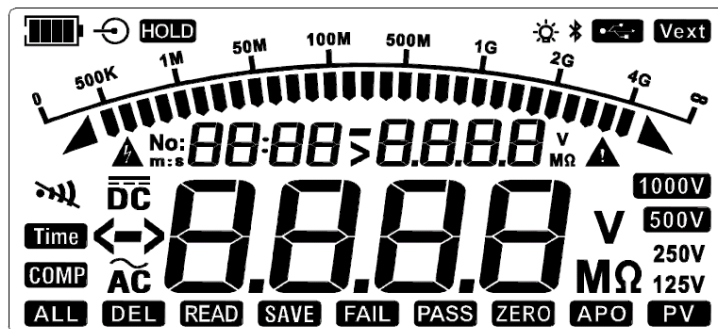







Figure 9.1 All segments shown on the LCD

(2) If the battery symbol shows the battery power is at “Level 1”, then the battery power almost runs out, please replace the battery. If the battery symbol shows the battery power is at “Level 0”, then the battery cannot provide the Tester with enough power to operate, so the battery must be replaced. The battery symbol (battery level) and corresponding battery voltage are shown in the table below:

Battery symbol	Battery voltage
 (Level 0)	$\leq 8.00V$ (Blink 10 sec at 2 Hz and then power off)
 (Level 1)	8.05~8.30V
 (Level 2)	8.35~8.60V
 (Level 3)	8.65~8.90V
 (Level 4)	$> 8.95V$

(3) If the test lead is damaged, broken, streaked or cracked, please stop use and contact the distributor or purchase new test leads from nearby franchised stores.

(4) If the test leads are not damaged, then connect the black test lead to the EARTH terminal and remote-controlled test lead to the LINE terminal.

(5) Connect the alligator clip or pen-shaped testing probe to the same-color test leads (connect according to corresponding color).

(6) For conventional insulation resistance measurement, short the remote-controlled test lead and the top end of black test lead, then press the TEST button to measure if the internal resistance of the test lead is about 0 M Ω . If the measurement result is greater than 0 M Ω , please check again if the test lead is connected to the terminal correctly and if the test lead is damaged internally.

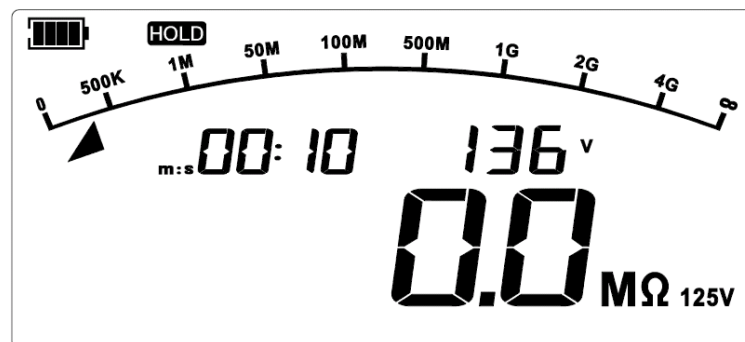

Figure 9.2 Test lead shorted

9.2 Battery Installation

1. With the front side facing down, loosen the screws, open the battery cover, and install the new batteries (AA *6) according to the correct polarity.
2. Close the battery cover and then tighten the screws.

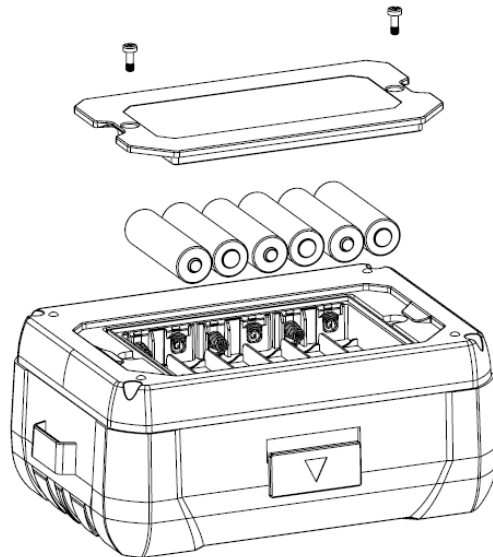

Figure 9.3 Battery installation

Note: To avoid electric shock, please power off the Tester and disconnect all test leads before replacing the batteries.

9.3 Basic measurement operations

9.3.1 Conventional insulation resistance measurement

Warning:

- ⚠ Please wear insulated gloves (corresponding to measurement category) and take protective measures before making connection and measurement.
- ⚠ Before test, please make sure that no voltage is present at the measured object, and please do not measure the insulation resistance of energized equipment or circuit (in conventional insulation resistance test mode).
- ⚠ Please make sure that the test leads contact the measured object well. Your hands shall be away from the test clips before pressing the TEST button to perform test.
- ⚠ Do not short the two test leads during test (in high voltage output state) or measure insulation resistance after outputting high voltage, otherwise it can cause personal injury, fire, or damage to the Tester.

$$\text{Formula: } R = \frac{U}{I} \text{ (Ohm's law)}$$

R: Measured insulation resistance

U: Output voltage

I: Current of measured loop

9.3.1.1 Continuous insulation resistance measurement

After boot-up, the Tester enters the 125 V position in continuous insulation resistance measurement mode by default. Connect the test leads to the measured object, press “▲” and “▼” to select high voltage, and press “◀” and “▶” to select fine-tuned step voltage.

Note: After boot-up, the backlight is turned on and the APO function is enabled by default. See the instructions about backlight and APO functions.

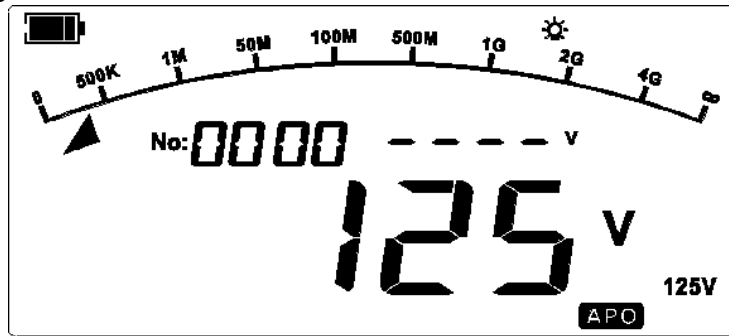

Figure 9.5 Continuous resistance measurement by default after boot-up

Press the TEST button to perform test, then the LCD shows the battery power, high voltage warning symbol (blink at 2 Hz), blinking buzzer symbol along with “beep”, real-time high output voltage, tested insulation resistance (the scrolling symbol “----” is displayed before measurement result is provided), test value of analog bar graph, continuous measurement time (start counting time when the test button is valid), and other related symbols.

Note: The testing time will be displayed as priority at the display zone of data storage and time. For time reading, the LCD shows the number of data once and then switches to display the time.

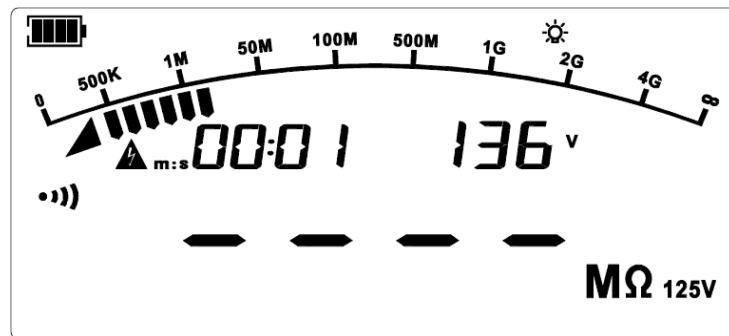

Figure 9.6 During continuous resistance measurement

Press the TEST button, then the measurement is stopped, the testing voltage of insulation resistance is turned off, the testing indicator light is turned off, the Tester discharges electricity (discharge capacitance 0.2uF) automatically at a fast speed, and the LCD holds the present measurement information and data.

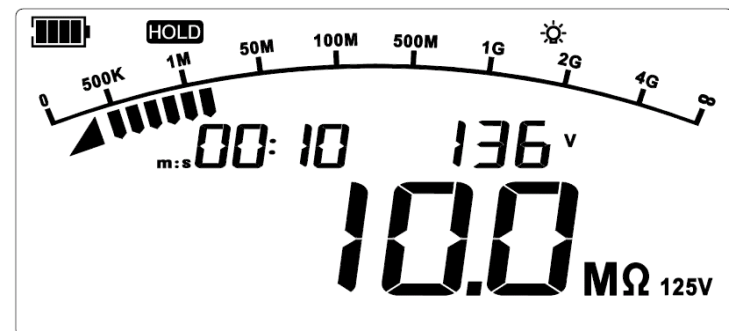

Figure 9.7 Continuous resistance measurement is stopped

9.3.1.2 Time-set insulation resistance measurement

In insulation resistance test function and without high voltage output, long press “▶” to select the timer measurement mode. In the timer measurement mode, the symbol “Time” appears on the LCD and the default countdown time “05:00” flashes (the ones digit of the “min” part flashes by default), to indicate that the time can be set. Then, short press “◀” and “▶” to select a digit place to be adjusted, short press “▲” and “▼” to adjust the value of the selected digit place, and short press the OK button to confirm and save the setting or press the main function button to cancel the setting.

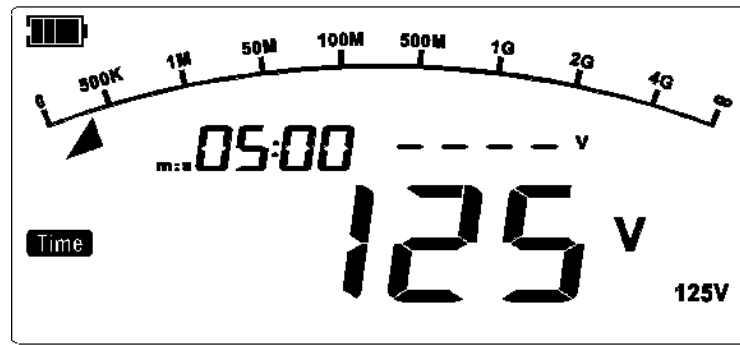

Figure 9.8 Timer measurement (Default interface)

Press the TEST button to perform test, then the countdown starts. When the set time is up, the test stops automatically, the testing indicator light is turned off, the Tester discharges electricity automatically at a fast speed, and the LCD holds the present measurement information and data.

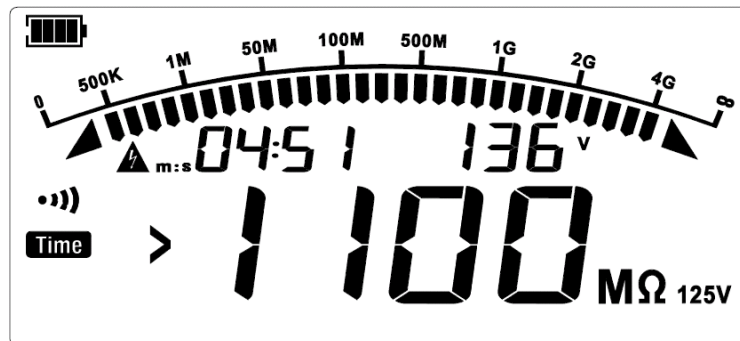

Figure 9. 9 Suspending measurement of timer (Default interface)

9.3.1.3 Comparative insulation resistance measurement

In insulation resistance test function and without high voltage output, long press “▶” to select comparative resistance measurement mode, then the symbol “COMP” appears on the LCD. The default comparative resistance is 10.00 MΩ, short press “◀” and “▶” to select a digit place to be adjusted, short press “▲” and “▼” to adjust the value of the selected digit place, and short press the OK button to confirm and save the setting or press the main function button to cancel the setting.

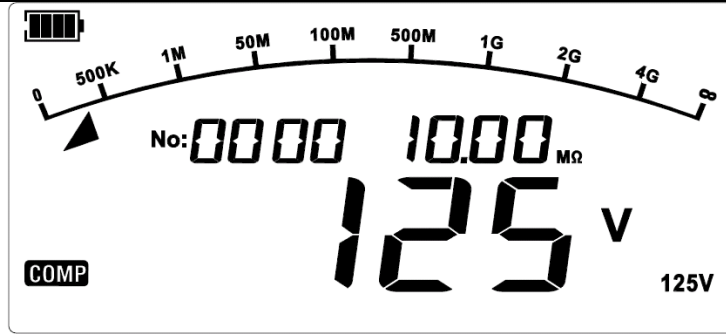

Figure 9.10 Comparative resistance measurement (Default interface)

Press the “TEST” button to perform test, then the LCD shows related symbols and testing result. If the measured insulation resistance is less than the preset resistance, the LCD shows “FAIL” or otherwise “PASS”.

Short press the “TEST” button, then the measurement is stopped, the testing voltage of insulation resistance is turned off, the testing indicator light is turned off, the Tester discharges electricity automatically at a fast speed, and the LCD holds the present measurement information and data.

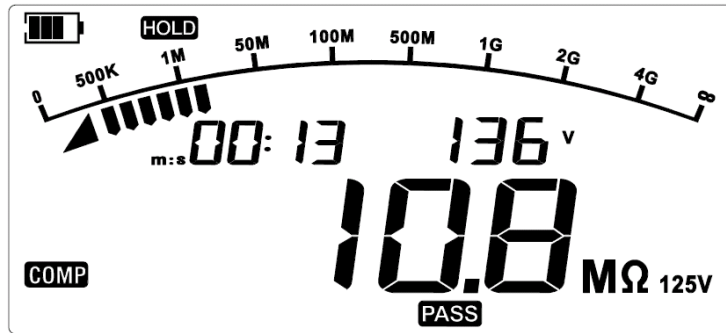

Figure 9.11 Comparative resistance measurement (10.0MΩ) is PASS

9.3.2 Photovoltaic (PV) energized insulation resistance measurement

The Tester can correctly measure the insulation resistance between solar panel and ground, without the effect of power generation on it. Apply the voltage V to the measured object, measure the applied voltage V and the leak current I flowing through the measured object, then calculate the resistance Rx of the measured object according to (Applied voltage V)/(Leak current I=I1+I2). (Subtract the voltage and current generated due to the power generation of the measured object).

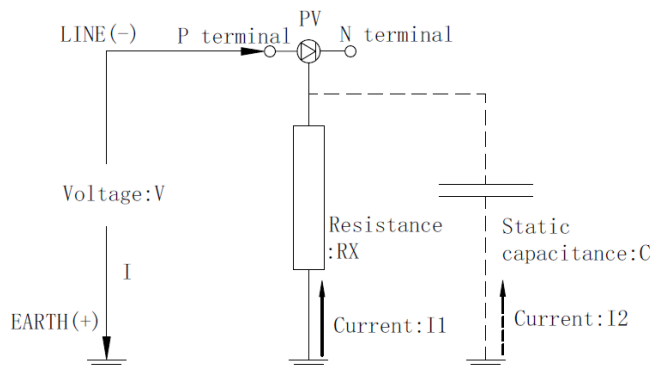

Figure 9.12 Photovoltaic (PV) resistance measurement principle

$$\text{Formula: } R = \frac{U}{I} \text{ (Ohm's law)}$$

⚠ Warning:

- In PV mode, if the Tester detects an AC voltage or a voltage of over 1000VDC, the buzzer sounds continuously, the backlight blinks at 1 Hz and the LCD flashes at 1 Hz. The Tester cannot measurement insulation resistance with an AC voltage or a voltage of over 1000VDC in PV mode.
- Do not measure any AC/DC energized object in conventional insulation resistance test mode, otherwise it may cause damage to the Tester or personal injury. Please disconnect the power supply of the measured object before use.
- The solar cell mainly generates power in day time and it can generate hazardous voltage. Please avoid electric shock when performing measurement in PV mode.
- Do not touch the metal part of the connection box or circuit breaker, otherwise electric shock accident may occur due to the voltage from power generation.
- The maximum rate voltage between terminals is DC 1000V or AC 600V. Do not measure any equipment with voltage of over DC 1000V or AC 600V, otherwise it can cause electric shock or fault.
- For measuring the circuit of an instrument with its withstand voltage lower than the testing voltage or the circuit of an instrument/component with unknown withstand voltage, please remove the instrument or component from the circuit before measurement.
- The static capacitance to ground of the solar panel is large, thus it may take a long time to stabilize the measurement value.
- Do not measure insulation resistance if the solar panel is faulty, otherwise it may damage the bypass diode connected to the solar panel.
- Measurement cannot be performed correctly if the open-circuit voltage of solar cell string or the energized voltage of other measured object is higher than the testing voltage. At PV 500V range, please use in the condition of open-circuit voltage of below 500V; at PV 1000V range, please use in the condition of open-circuit voltage of below 1000V.
- The insulation resistance is the rate between applied voltage and leak current. The displayed value may be unstable due to the measured object (this is not because the Tester is fault).
- When the PV measurement function is used, there is a current-limiting resistance of $1\text{M}\Omega$ connected to the EARTH terminal, so the output voltage will be divided by $1\text{M}\Omega$ and the resistance of the measurement terminal. For example, when measuring a resistance of $10\text{M}\Omega$, the output voltage will be divided by $1\text{M}\Omega$ and $10\text{M}\Omega$.

Measurement preparations:

1. For measuring solar panel, please set the main switch 1 of the connection box to OFF, and disconnect with the power regulator.
2. Set the circuit breaker 2 of all strings to OFF.
3. If there is a lightning arrester with the measurement path, please disconnect the lightning arrester.

In the situation as shown in the figure below, there is no lightning arrester at the string side of the circuit breaker, so the lightning arrester does not need to be disconnected.

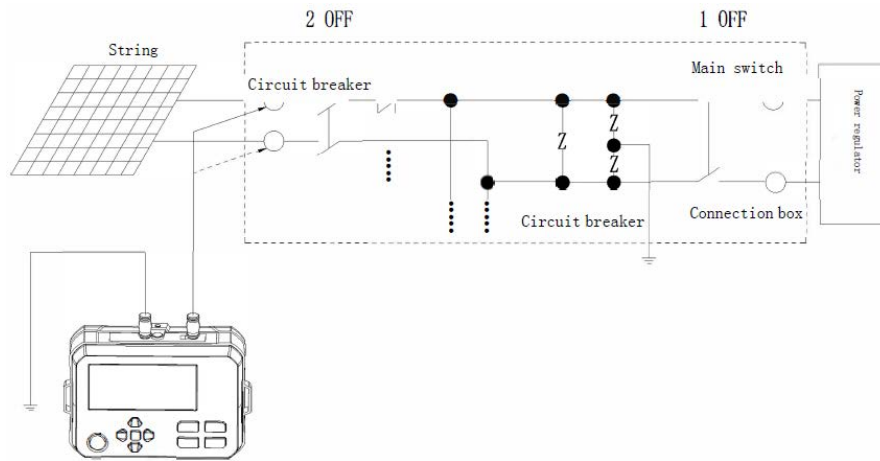

Figure 9.13 Photovoltaic equipment

Measuring steps:

1. Confirm that the TEST button is not pressed or the switch button of remote-controlled test rod is not pressed.
2. Switch the insulation resistance testing mode to photovoltaic (PV) insulation resistance testing mode.
3. Press “▲” and “▼” to select 500V (default) or 1000V position, and press “◀” and “▶” to adjust the step voltage of the selected position.
4. Connect the black test lead to the ground terminal.
5. Connect the remote-controlled test lead to the P terminal of the string (or use the MC4 connectors along with the test lead).
6. Press the TEST button to start measurement, then the Tester automatically calculate the measurement data and display them on the LCD.
7. After the test is completed, press the TEST button to stop measurement, then the Tester starts discharging electricity automatically, and the high voltage symbol and the safety warning symbol blink. Since the solar panel will generate voltage, the high voltage symbol will not disappear after completing discharging electricity, please do not touch the energized electric wire.

After the measurement is completed:

1. Measure the insulation resistance of all strings, then remove the black test lead from the ground terminal.
2. Please recover the lightning arrester if it is disconnected.
3. Set the circuit breakers of all strings to ON.
4. Recover the main switch of the connection box.

9.3.2.1 Photovoltaic (PV) continuous insulation resistance measurement

By default, the Tester enters the continuous measurement mode (position: 125V) of conventional insulation resistance after boot-up. Long press the “IR” button for about 2 sec to switch to “PV (IR)” mode, the 500V position is displayed on the LCD in “PV (IR)” mode by default. Press “▲” and “▼” to select the output voltage, and press “◀” and “▶” to select fine-tuned step voltage.

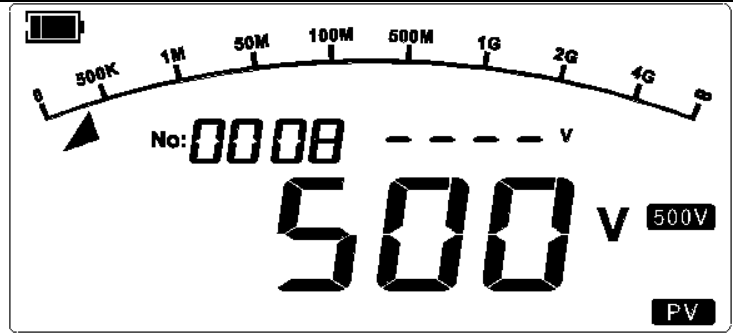

Figure 9.14 Continuous resistance measurement by default after boot-up

Connect the test leads to the measured object, press the TEST button to start test, then the LCD shows corresponding test result and symbol.

Note: The Tester will detect external energized voltage as priority before test. If the detected voltage exceeds 1000V DC or the voltage of the selected position, then no high voltage output will occurs, the LCD flashes at 2 Hz, and the buzzer sounds continuously. If the measurement is normal, the real-time voltage at the terminal of the equipment will be displayed.

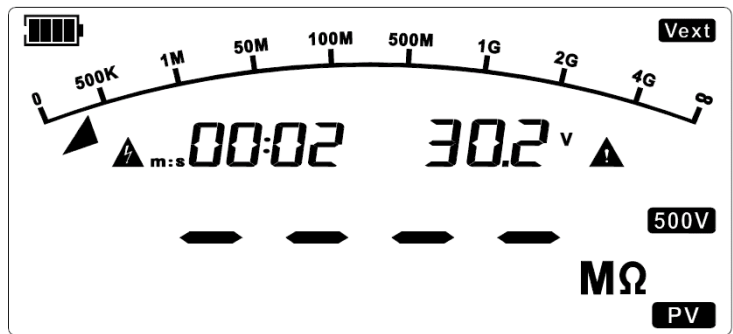

Figure 9.15 External energized voltage is detected in PV continuous resistance measure mode

Press the “TEST” button, then the measurement is stopped, the testing voltage of insulation resistance is turned off, the testing indicator light is turned off, the Tester discharges electricity automatically at a fast speed, and the LCD holds the present measurement information and data.

Note: Since the external energized voltage exceeds 25 V after the test is completed, the external energized voltage symbol and the terminal voltage will be displayed on the HOLD interface, and the high voltage symbol and the safety warning symbol will blink.

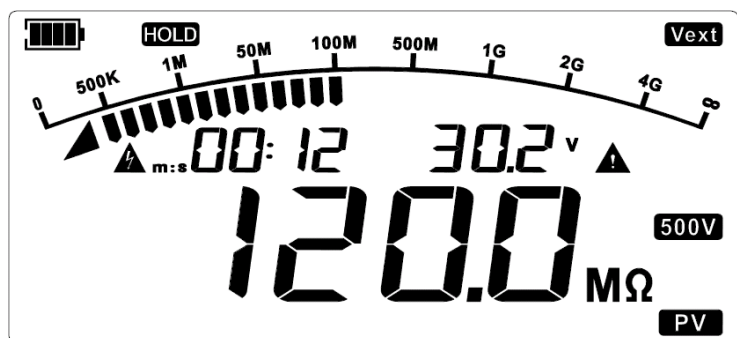

Figure 9.16 PV continuous measurement is stopped

9.3.2.2 Photovoltaic (PV) time-set insulation resistance measurement

In photovoltaic (PV) insulation resistance test mode and without high voltage output, long press “▶” to select the timer measurement mode (TIME), the default set time is “05:00”. Then, short press “◀” and “▶” to select a digit place to be adjusted, short press “▲” and “▼” to adjust the value of the selected digit place, and short press the OK button to confirm and save the setting or press the main function button to cancel the setting.

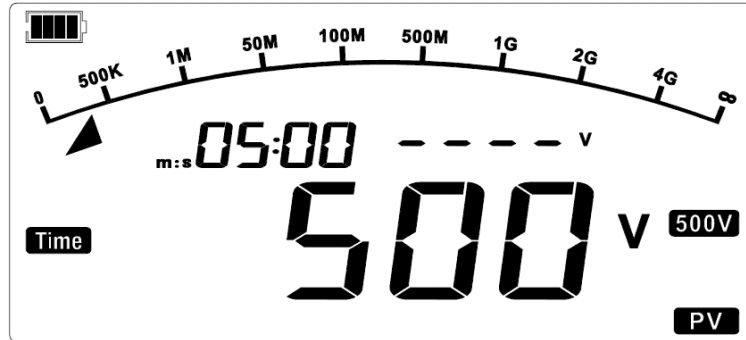

Figure 9.17 PV time-set measurement (Default interface)

Press the “TEST” button to perform test, then the LCD shows corresponding symbol and test result.

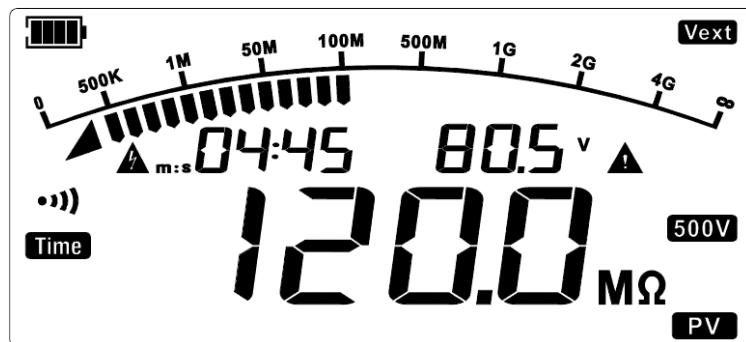

Figure 9.18 During PV timer measurement

When the set time is up, the test stops automatically, the testing indicator light is turned off, the Tester discharges electricity automatically at a fast speed, and the LCD holds the present measurement information and data.

9.3.2.3 Photovoltaic (PV) comparative insulation resistance measurement

In insulation resistance test mode and without high voltage output, long press “▶” to select the comparative resistance measurement mode (COMP), the default comparative resistance is 10.00 MΩ. Then, short press “◀” and “▶” to select a digit place to be adjusted, short press “▲” and “▼” to adjust the value of the selected digit place, and short press the OK button to confirm and save the setting or press the main function button to cancel the setting.

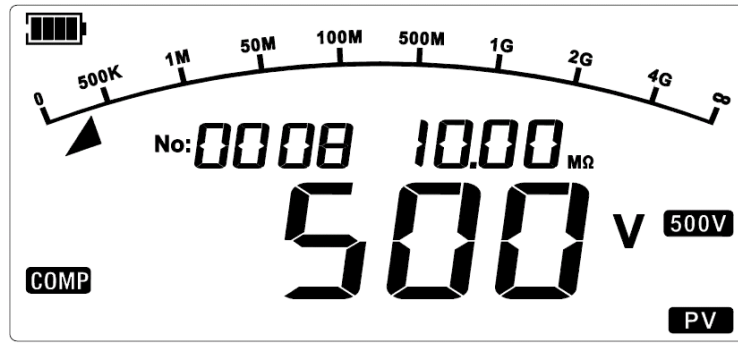

Figure 9.19 PV comparative resistance measurement (Default interface)

Press the “TEST” button to perform test, then the LCD shows corresponding symbol and test result. If the measured insulation resistance is less than the preset resistance, the LCD shows “FAIL” or otherwise “PASS”.

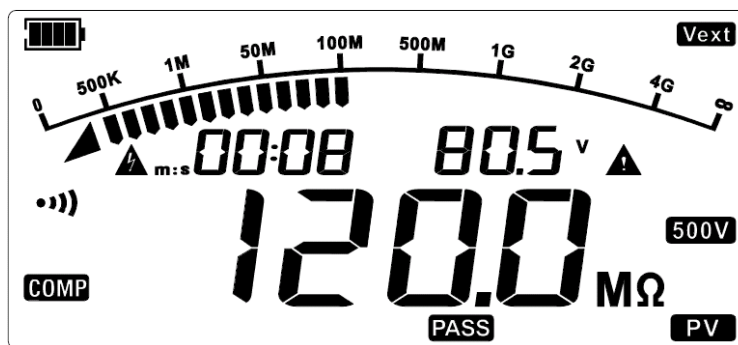

Figure 9.20 PV comparative measurement is PASS

Short press the TEST button, then the measurement is stopped, the testing voltage of insulation resistance is turned off, the testing indicator light is turned off, the Tester discharges electricity automatically at a fast speed, and the LCD holds the present corresponding symbol.

9.3.3 Voltage measurement

Short press the “DCV/ACV” button to enter the automatic AC/DC voltage measurement mode. The default interface is shown in the Figure below:



Figure 9.21 AC/DC voltage measurement (Default interface)

Connect the red test lead to the “LINE” terminal and black to “EARTH”, then connect the red and black alligator clips to the measured circuit. The measured AC voltage is 220 V, as shown in the

Figure below:

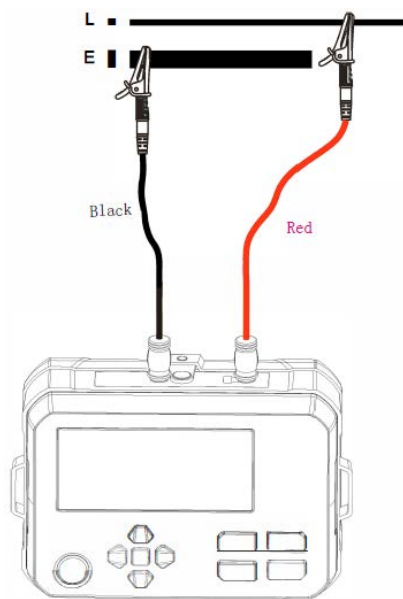

Figure 9.22 Connection of voltage measurement



Figure 9.23 AC voltage measurement

If the red test lead is the negative voltage when measuring DC voltage, the negative symbol “-” will be displayed on the LCD. As shown in the Figure below:



Figure 9.24 Negative DC voltage measurement

Warning:

⚠ Do not measure voltage of over 600V AC or 1000V DC. It is possible to display higher voltage (5%), but it may damage the Tester.

- ⚠ Please pay particular attention to avoid electric shock when measuring high voltage.
- ⚠ After all measurement operations are completed, please disconnect the test leads with the measured object and remove the test leads from the input terminal of the Tester.

10. Conventional Connecting methods

10.1 Testing of conventional insulation resistance of cables

Measure conventional insulation resistance in two-wire method

There is leak current at the surface of the inner insulation layer near the cable end. The leak current also exists in the measured current of the “-” terminal, which will cause the measured resistance to be lower than the actual insulation resistance. As shown in the Figure below:

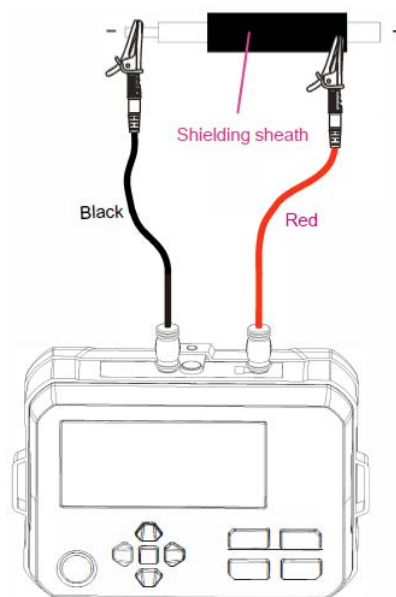

Figure 10.1 Conventional measurement in two-wire method

10.2 Testing of conventional insulation resistance of transformer

- A. Measure the insulation resistance between primary winding and ground of secondary winding

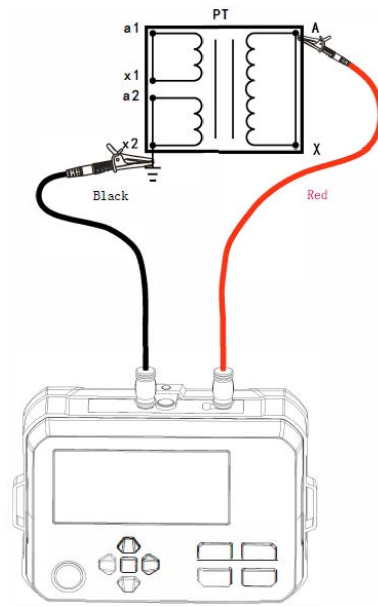

Figure 10.2 Connection diagram

B. Measure the insulation resistance between ground of primary winding and secondary winding

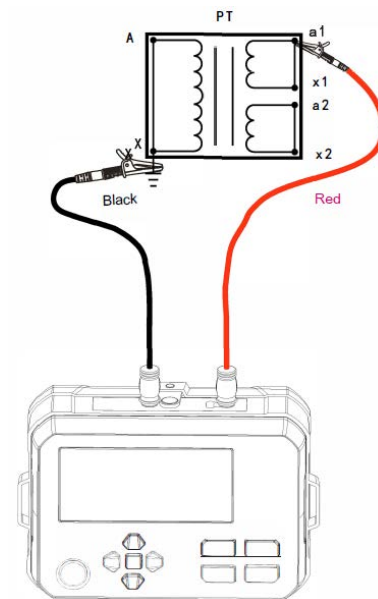

Figure 10.3 Connection diagram

C. Measure the insulation resistance between secondary windings

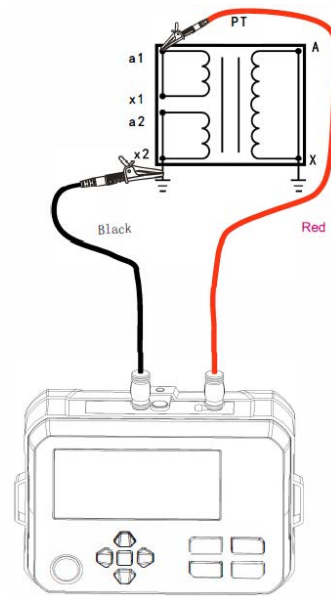

Figure 10.4 Connection diagram

10.3 Testing of photovoltaic insulation resistance

There are two methods to test photovoltaic insulation resistance according to IEC 62446-1. Measurement can be performed according one of the two methods, the followings are the characteristics of these methods.

A. Measure between P and N in open-circuit state

This method describes the PV Ω measurement function in the User Manual. Since the testing voltage will be affected by the solar array voltage, correct measurement result may not be obtained sometime. Additionally, incorrect steps may cause damage to the solar panel. As shown in the Figure below: When leakage occurs due to faulty ground, the insulation resistance meter will be affected by the current from power generation, which causes the conventional insulation resistance meter to be unable to perform measurement normally. In the PV Ω measurement mode of the Tester, the measurement can be performed normally and will not be affected.

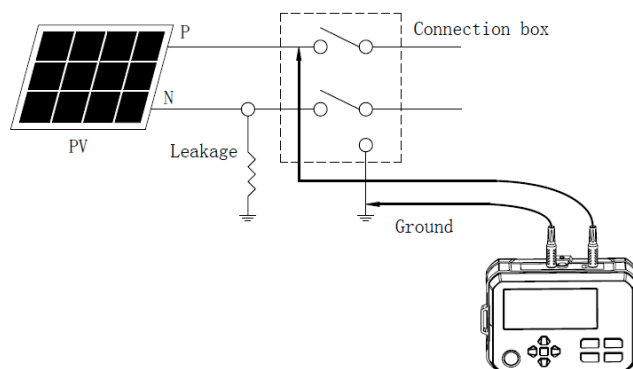

Figure 10.5 Measure between P and N in open-circuit state

B. Measure between P and N in short-circuit state

Please perform measurement between P and N in short-circuit state when the solar panel does not generate power at night or in other situation. When performing insulation resistance test on

the solar array circuit, please prepare a switch that can withstand the short-circuit current of the solar array, since there is relatively high voltage at the solar array in day time. Short the output terminal of the solar array using the short-circuit switch, then perform test in $PV\Omega$ measurement mode of the Tester.

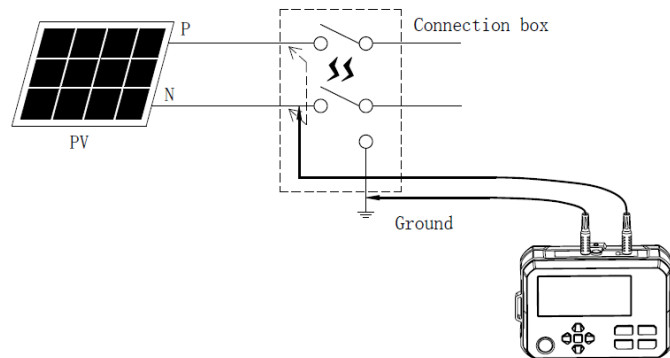

Figure 10.6 Measure between P and N in short-circuit state

If the insulation resistance cannot be performed correctly by using the above methods, please perform insulation resistance test in a wet state. The wet-state manner is same as the testing methods above, but water and surface active mixture need to be sprayed on the surface of the measured equipment before test, to simulate the insulation resistance of the system in rain or with condensation. Please check the area of the measured array before test, to ensure all parts (including the front, rear and edge of the module) and all connection boxes and cables are wet.

11. Technical Specifications

Accuracy: \pm (a% of reading + b digits); one-year warranty

Ambient temperature: $23\pm 5^{\circ}\text{C}$ ($73.4^{\circ}\text{F} \pm 9^{\circ}\text{F}$)

Ambient humidity: 45~75%RH

Temperature coefficient: For testing out of specified temperature range (i.e., $>28^{\circ}\text{C}$ or $<18^{\circ}\text{C}$), the testing error is increased by $\pm 0.25\%$ per degree Celsius.

11.1 Specifications for conventional insulation resistance measurement

Position	Measurement range	Measurement accuracy	Overrange indication	Short-circuit current
125V	<1.51MΩ	For reference only	>1100MΩ	<1.5mA On-load current capacity (Only applicable to conventional insulation resistance measurement): 1mA~1.2 mA (125V, 0.125 MΩ; 250V, 0.25 MΩ; 500V, 0.5 MΩ; 1000V, 1.0 MΩ)
	1.51MΩ~100.0MΩ	±(1.5%+5)		
	100.1MΩ~1000MΩ	±(5%+6)		
250V	<1.51MΩ	For reference only	>2200MΩ	
	1.51MΩ~200.0MΩ	±(1.5%+5)		
	200.1MΩ~2000MΩ	±(5%+6)		
500V	<1.51MΩ	For reference only	>4200MΩ	
	1.51MΩ~1000MΩ	±(1.5%+5)		
	1001MΩ~4000MΩ	±(5%+6)		
1000V	<1.51MΩ	For reference only	>4200MΩ	
	1.51MΩ~1000MΩ	±(1.5%+5)		
	1001MΩ~4000MΩ	±(5%+6)		

1 MΩ (Mega ohm) = 1000KΩ = 10⁶Ω

Note: For insulation resistance measurement, a large offset value may occurs if the measured capacitive reactance is greater than about 100nF.

11.2 Specifications for photovoltaic (PV) insulation resistance measurement

Position	Measurement range	Measurement accuracy	Overrange indication	Short-circuit current
500V	<1.51MΩ	For reference only	>4200MΩ	<1.2mA
	1.51MΩ~1000MΩ	±(1.5%+5)		
	1001MΩ~4000MΩ	±(5%+6)		
1000V	<1.51MΩ	For reference only	>4200MΩ	
	1.51MΩ~1000MΩ	±(1.5%+5)		
	1001MΩ~4000MΩ	±(5%+6)		

Note:

- Measurement cannot be performed correctly if the open-circuit voltage of solar cell string or the energized voltage of other measured object is higher than the testing voltage. At PV 500V range, please use in the condition of open-circuit voltage of below 500V; at PV 1000V range, please use in the condition of open-circuit voltage of below 1000V.
- For measured object with voltage of over 900VDC, the measurement result is for reference only.

11.3 Specifications for the output voltage of conventional insulation

resistance

Rated voltage	Output accuracy	Display accuracy	Output voltage range	Remark
125V	+ (0%~20%)	1V	125V~150V	In conventional testing mode, the step voltage can be adjusted as: For 125V position: 125V, 138V, 150V For 250V position: 125V, 150V, 175V, 200V, 225V, 250V, 275V, 300V For 500V position: 250V, 300V, 350V, 400V, 450V, 500V, 550V, 600V For 1000V position: 500V, 600V, 700V, 800V, 900V, 1000V
250V			250V~300V	
500V			500V~600V	
1000V			1000V~1200V	

11.4 Specifications for the output voltage of photovoltaic (PV) insulation

resistance

Rated voltage	Output accuracy	Display accuracy	Output voltage range	Remark
500V	+ (0%~20%)	1V	500V~600V	In PV testing mode, the step voltage can be adjusted as: For 500V position: 500V, 550V, 600V For 1000V position: 500V, 600V, 700V, 800V, 900V, 1000V, 1100V
1000V			1000V~1200V	

Note: When the PV measurement function is used, there is a current-limiting resistance of 1MΩ connected to the EARTH terminal, so the output voltage will be divided by 1MΩ and the resistance of the measurement terminal. For example, when measuring a resistance of 10MΩ, the output voltage will be divided by 1MΩ and 10MΩ.

11.5 Specifications for AC/DC voltage measurement

Voltage measurement	Measurement range	Measurement accuracy	Range	Resolution	Overrange indication
DC voltage	5~1000V	±(1%+4)	500V: 5.0~499.9V	0.1V	>1050V
			1000V: 500~1050V	1V	
	-5~-1000V		-500V: -5.0~499.9V	0.1V	>-1050V
			-1000V: -500~1050V	1V	
AC voltage	5~600V 50Hz/60Hz		300V: 5.0~299.9V	0.1V	>630V
			600V: 300~630V	1V	

Note: If the detected voltage exceeds the voltage testing range specified by the Tester, the LCD will provide an indication of over-voltage.

11.6 Conventional specifications

Power supply	6X1.5V LR6 AA alkaline batteries
Rated voltage	125V, 250V, 500V, 1000V
Output voltage accuracy	+ (0%~20%)
Testing range of insulation resistance	0.125MΩ~4000MΩ
Testing range of PV insulation resistance	0.50MΩ~4000MΩ
Output short-circuit current	<1.5mA
Continuous measurement of insulation resistance	√ (Default measurement mode)
Time-set measurement	√
Comparative measurement of resistance	√
Voltage testing	Automatic identification of AC/DC voltage
Voltage step	√
Test with external voltage	In conventional insulation resistance testing mode, it is forbidden to test if the external AC/DC voltage is greater than about 25V. In PV mode, insulation resistance with external DC voltage of less than 1000V can be tested.
Timer	Record testing time automatically. Timing range: 0 sec~99 min and 59 sec
High voltage warning	If safety voltage is exceeded, the hazardous voltage symbol will flash.

Automatic discharge	√
Backlight	Manual/Automatic backlight
Storage function	Capable to save 1000 sets of testing data
Communication functions	Upload the data to PC (unidirectional) via USB cable.
	Data can be uploaded and distributed via the Bluetooth APP.
Displaying battery power	√ (If low battery indication occurs, an indication of charging in time is provided)
Auto power off	The Tester powers off after it is ON for 10 minutes (without high voltage being generated and without any operation)
Tester dimensions	161(L) × 117.3(D) × 63(H) mm
Tester weight	0.5kg (including battery)
Operating altitude	≤2000m
Drop proof	1 m
IP rating	IP54 (Overall protection with cover closed)
Pollution degree	2
Intended use	Indoor use
Operating environment	0°C~40°C: <80%RH (No condensation)
	40°C~50°C: <70%RH
Storage environment	-20°C~60°C: <75% (No condensation)
Measurement category	CAT II 1000Vdc, CAT III 600V
Regulatory compliance	CE EN 61010-1; EN IEC 61010-2-034; EN 61557-1, -2.

Remark:

1. Possible number of measurements where battery voltage is within the effective range: Approx. 790 times (output 1000Vdc load 1MΩ, cycling: 5s ON/25s OFF).

2. Operational uncertainty

Intrinsic uncertainty or influence quantity	Designation code	Max value
Intrinsic uncertainty	IEC 61557-2 A Reference conditions	3%
Position	IEC 61557-2 E1 ±90 °	3%
Supply voltage	IEC 61557-2 E2	3%
Temperature	IEC 61557-2 E3 0°C and 40°C	4%
Operating uncertainty	IEC 61557-2 B ≤30%	17.8%

12. Communication Functions

The Tester supports communication with PC and Bluetooth APP.

12.1 Connect with PC via USB cable

The Tester can be connected with a Type-C USB cable, as shown in the Figure below.

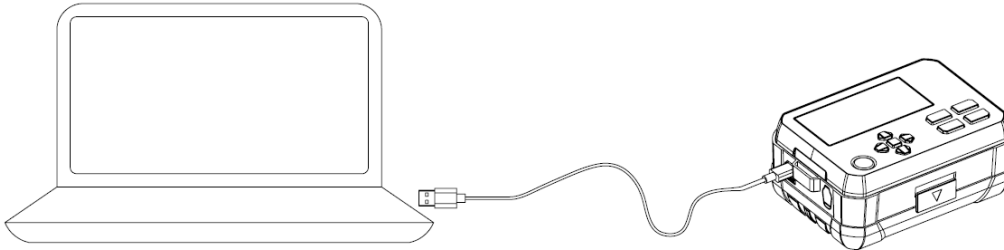

:

- Download the corresponding PC software from the official website of Uni-Trend, and install it according to the installation instructions.
- Support Win 7 or above system.
- Use the Type-C USB cable to connect the Tester with the PC.
- Long press the up arrow button on the Tester and the “USB” symbol will appear at the LCD (See the section “Button Functions” in the User Manual). The data of the Tester is available for USB communication.
- Run the PC software and click on the “Connect” option. Then the PC is available for USB communication and the data of the Tester will be displayed on the PC in real time.

Note: Data of the PC cannot be transmitted to the Tester.

12.2 Bluetooth software

12.2.1. Introduction

The Bluetooth software is a mobile APP and supports iOS 10.0 or newer and Android 5.0 or newer currently.

12.2.2. Download (iDMM2.0)

1) For Android

Method 1: Search “iDMM2.0” from the official website of Uni-Trend.

Method 2: Open the mobile browser and scan the QR code below (Do not scan by WeChat).

Method 3: Search “iDMM2.0” at Google Play, Tencent My App, HUAWEI APP store, MI APP store, VIVO APP store, and OPPO APP store.

Method 1 or 2 is highly recommended for downloading latest software.

2) For IOS

Method 1: Search “iDMM2.0” at “App Store”.



For Android



For IOS

12.2.3. Use

1) Open the Bluetooth functions of both the Tester and mobile phone, tap the “iDMM2.0” APP icon on your phone desktop to open the software, then the software enters the navigation interface and searches nearby Bluetooth-enabled meters automatically. After that, select the corresponding meter and make connection. Alternatively, scan the QR code at the meter to make direct connection. In connected state, data communication, measurement result display, button control and other operations can be achieved.

2) “iDMM2.0” APP has multiple functions including Bluetooth communication, data recording, device management, report generation, data sharing, data synchronizing, and more. For the operating instructions about these functions, please refer to the “iDMM2.0” User Manual (Tap the menu button, “Setting” button, then “Help Guide” button for the User Manual)

12.2.4. Uninstallation

Uninstall the software through the uninstallation function of mobile phone.

13. Maintenance

Clean the casing:

1. Wipe the casing using soft cloth or sponge moistened with clear water.
2. Do not immerse the Tester into water!
3. Please dry the Tester before storage.
4. The calibration or maintenance shall be performed by professional personnel or designated servicing center.

The contents of the manual are subject to change without further notice!

UNI-T®**UNI-TREND TECHNOLOGY (CHINA) CO., LTD.**

No.6, Gong Ye Bei 1st Road,
Songshan Lake National High-Tech Industrial
Development Zone, Dongguan City,
Guangdong Province, China